

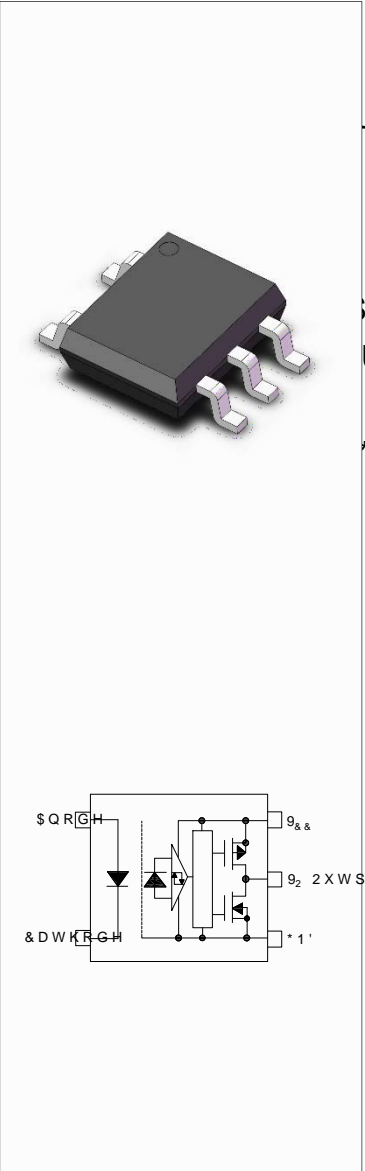

7KH SURGXFWV DURS W B WFR XGSLYUW LQ
 SDFNDJH 7KH GHYLDQ FLQQVDUWG R(' R
 FRXSOHG WR DQ LQVQH JKLDW HVS KH GKSJK
 , & FKLS , W SURYLGHV JXDUDQWHHG S
 DW WHPSHUDWXU W XS WR VLFDOO\ VP
 FRPSOLDQW ZLWK LQWHUQDWLRQDO V
 LQVXODWLRQ , W WKXV SURYLGHV D V
 IRU DSSOLFDWLRQV WKDW UHTXLUH V
 LQWHUQDO QR LGHHV D LKHOG DSSURMHG FR
 WUDQVLHQW LPPXQLW\LRILGHDO MRU
 DQG SRZHU 026)(7 JDWH GULYH 7KH S
 LQ LQGXFVWULDO LQGHUWHUV 026)(7D
 LQGXFWLRQ FRRNWRS DQG KRPH DSSO



J
 QG VSI
 UGV IR
 SULQW
 UG FHU
 *
 ZLGHO

\$ PD[LXP SHDN RXWSXW FXUUHQW
 +LJK LVRODWLRQ 9506
 %XIIHU ORJLF W\SH
 2SHUDWLQJ WHPSHUJHWXU WR f &
 5(\$+ 5R+6 FRPSOLDQFH
 +%0 + \$ 00 0 &'0 &
 &4& DSSURYHG
 9'(DSSURYHG
 8/ DSSURYHG

,Q SXW	/(')	2 X W S X W
+	21	/
/	2))	+

7HPSHUDWXUH f &

)RUZDUG &XUUHQW)	,	
/(')	3HDN)RUZDUG &XUUHQW	W ₃	7	\$
	5HYHUVH 9ROWDJH	9 ₅		



	3RZHU 'LVVLSDWLRQ	3'		P :
'HWHFWRU	2XWSXW 9ROWDJH	2	9	
	6XSSO\ 9ROWDJH	9&&		
	3RZHU 'LVVLSDWLRQ	3&		P :
,VRODWLRQ 9ROWDJH	9LVR		8	9UPV
2SHUDWLQJ 7HPSHUDWXUH	7RSU		a	
-XQFWLRQ 7HPSHUDWXUH	7M			
6WRUDJH 7HPSHUDWXUH	7VWJ		a	
7RWDO 3RZHU 'LVVLSDWLRQ	3WRW			P :
6ROGHULQJ 7HPSHUDWXUH	7VRO			

íîì • %µο• U íîì, Ì (œ ‹µ v Ç
{)œ íu]vµš U ZX, XAđì• òì9

7HPSHUDWXUH f &

, Q SXW)RUZDUG 9ROWDJH)) 9P\$,			9	
	5HYHUVH &XUUHQW	5 9	9			\$	
	7HUPLQDO &DSDFLWDQGH I 0+&					S)	
3HDN +LJK OHYHO 2XWSXW* 1' &XUUHQW	,23+) P\$	9&& 9			P\$	
) P\$	9&& 9			P\$	
		9 ₂ * 1'					
	,23/	3HDN /RZ OHYHO 2XWSXW 9 ₂ 9	9&& 9 ₂ 9				P\$
		&XUUHQW					P\$
2XWSXW	, & +	+LJK /HYHO 6XSSO\ &XUUHQW) P\$	9&& 9		P\$	
) P\$	9&& 9			P\$	

Pitubc0P\$=VF&3 €H

/RZ /HYH—B% €0 A & Qq"v 00, €1



			9) 9				9
			.2 P\$				
	7KUHVKROG ,Q SXW &XUUHQW) / +	9&& 9 9 ₂ Ú 9				P\$
	7KUHVKROG ,Q SXW 9ROWDJH	9) + /	9&& 9 9 ₂ Ø 9				9
	6XSSO\ 9ROWD	JH 9&&					9

	3URSDJDWLRQ 'HOD\ 7LPH WR +LJK 2XWSXW /HYHO	W+	5J &J Q)) : P\$ 9&& 9				
	3URSDJDWLRQ 'HOD\ 7LPH WR /RZ 2XWSXW /HYHO	W /	5J &J Q)) : P\$ 9&& 9				
	3URSDJDWLRQ 'HOD\ 'LIIHUHQFH %HWZHHQ \$Q\ 7ZR 3DUWV	W / , W	5J &J Q)) 8 : P\$ 9&& 9				Q V
	2XWSXW 5LVH 7LPH	WR	5J &J Q)) : P\$ 9&& 9				
	2XWSXW)DOO 7LPH	WR	5J &J Q)) : P\$ 9&& 9				
	&RPPRQ 0RGH 7UDQVLHQW ,PPXQLW\ DW +LJK /HYHO	&0 7D 9 ₂) P\$ 9&& 9 PLQ 9&0 9SS				N9 V
	&RPPRQ 0RGH 7UDQVLHQW ,PPXQLW\ DW /RZ /HYHO	&0 7D 9 ₂) P\$ 9&& 9 PD[9&0 9SS				N9 V

oo dÇ%o] o Āîñµ • š d
W /v%o µš •]Pv o ~(Āîñl, ìU µšÇĀñ]i9 b š•œšZš (vĀ ññ •%o)œ Āoz]•Z X]v
%oœ} v •šœ Ç Ā]œ]vP %o]š v X



, Q S X W 2 Q V W D W H ,) & X U U H Q W					P \$
, Q S X W 2 I I V W D W H , 9 R , O W D J H			9		
6 X S S O \ 9 R O W D J H 9 & &					9
2 S H U D W L Q J) U H T X H Q F V					N +]

W dZ OE }uu v }%o OE š]vP }v]š]}v} OE P]•À OE Ç •š} } š] Pw
]vš v %o OE (}OE u v }(šZ À] X Zv %ov OE Àu ošµ OE]•Z w]OE %o]
•Ç•š u •]Pv µ•]vP ššZ]•o Àš]OE]U o Z•%E]š]OE]}š]šZ]š •Z}µo o•}
}v•] OE X
W OE u] %o]š}OE ~iXí... &• •Z}µo s }v v v š %o]v šŮÁ ~vE %o]š
•š]o]í šZ }%o OE P]]v }p]v ZŮEP Zur%o o] (] OE X KšZ OE Á]• U šZ]• %o Z
%o OE }%o OE oÇX dZ Ç]µo•• %o o]š}OE Á]šZ]Z í%o]v X(
W dZ OE]• v (oo š]u • }(šZ]v%o µšZ}vriš OE OE •vš •Z}µo
W /(šZ OE]•]vP •o}%o }(šZ (}OE %o Z o Ç Á}oš}OE]•s•š %o U •š o
]vš OE v o]OE µ]š• v šv}š P µ OE OE š} • š ě sl...• }OE o •• X}OE OE]•
W v}š • šZ }%o OE }š]šZ OE v P] u u v }%o]OE]š]X P }

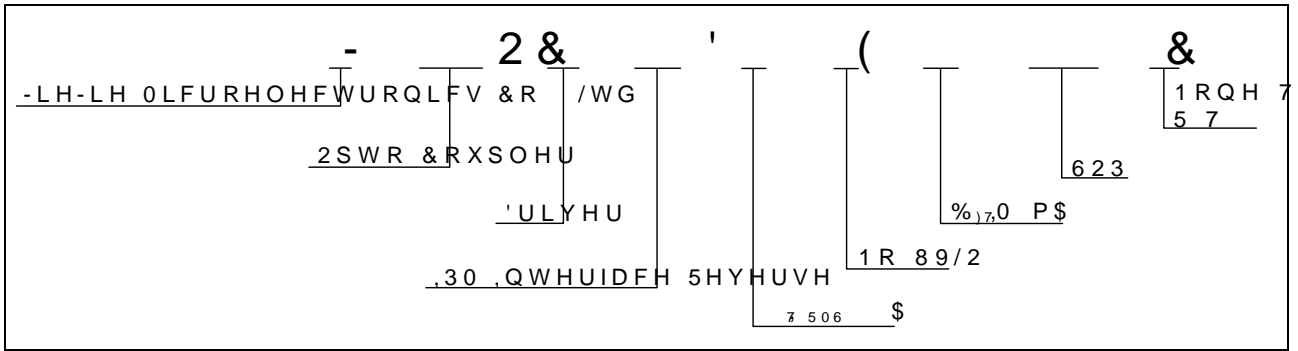



/RZ OHYHO 2WWSXW V9RSD
7HPSHUDWXUH

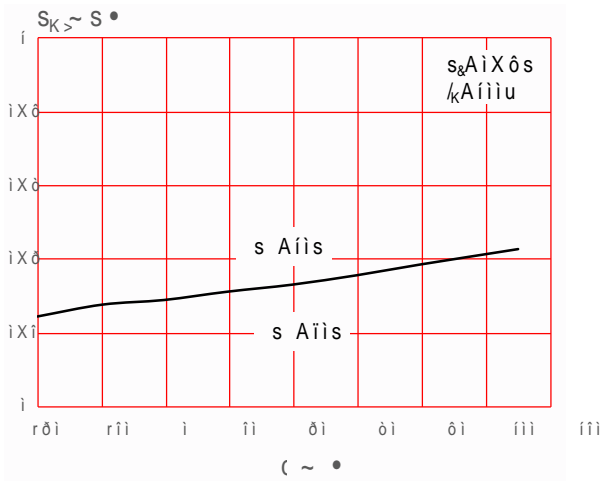

+LJK OHYHOR 2XWSXW 9
7HPSHUDWXUH

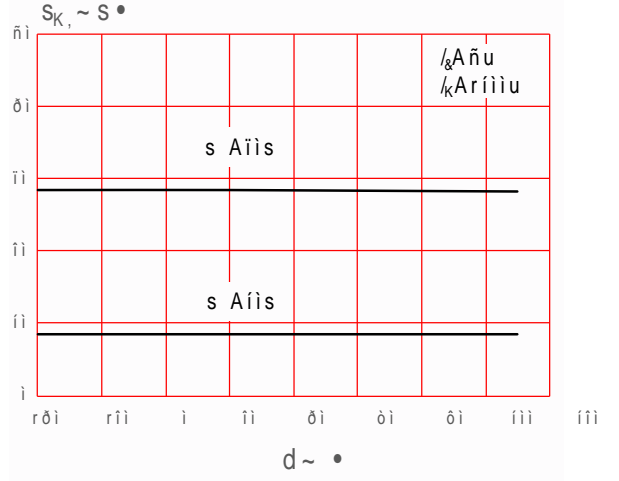

/RZ OHYHO 2WWSXW V9RSD /RZ
OHYHO 2XWSXW &XUUHQW

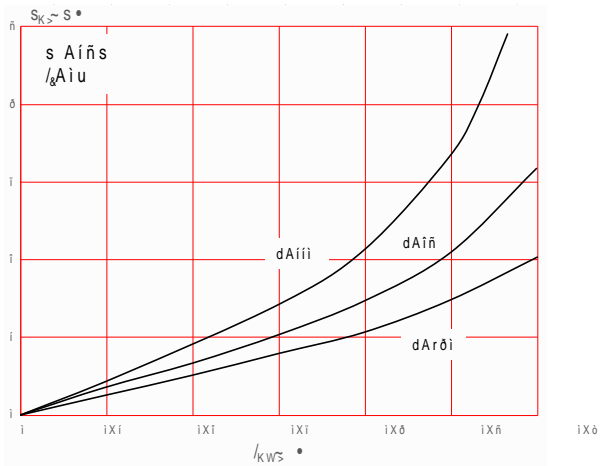

+LJK OHYHO 2XWSXW 9ROWD
3HDN +LJK OHYHO 2XWSXW &XUUHQW

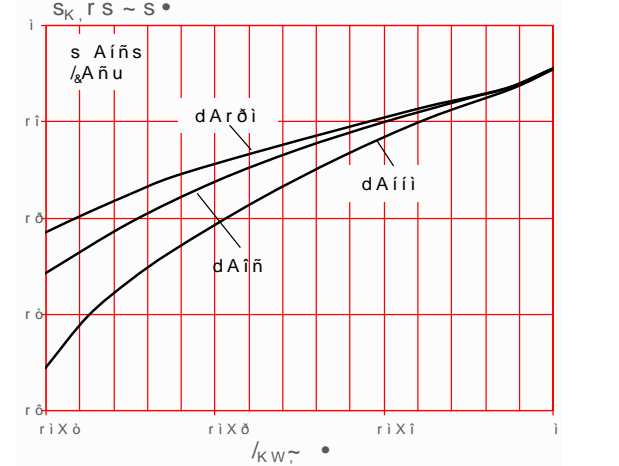

3URSDJDWLRQ 'HOD\ 7LPH 3XOVH :3GURSDJDWLRQ 'HOD\ 7LPH 3XOVH
'LVWRUWLRQ YV \$PELHQW 7HPSHUDWXUH 'LVWRUWLRQ YV)RUZDUG

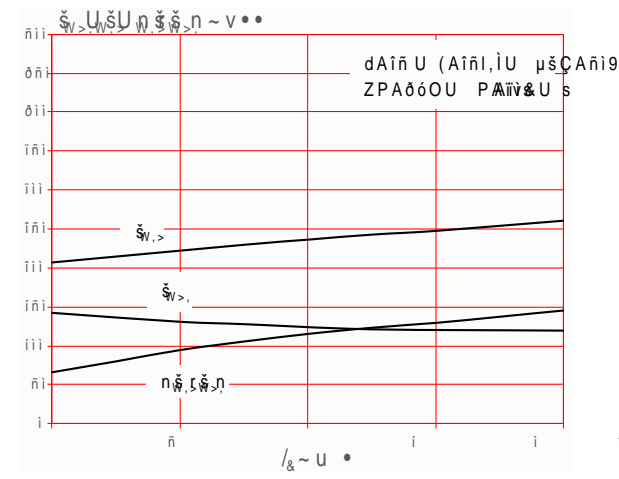
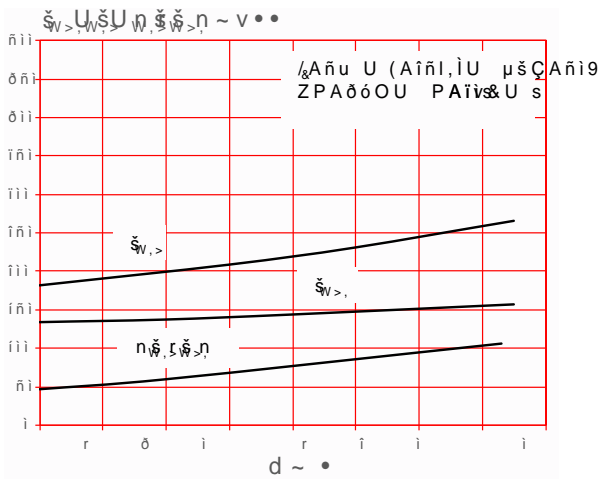

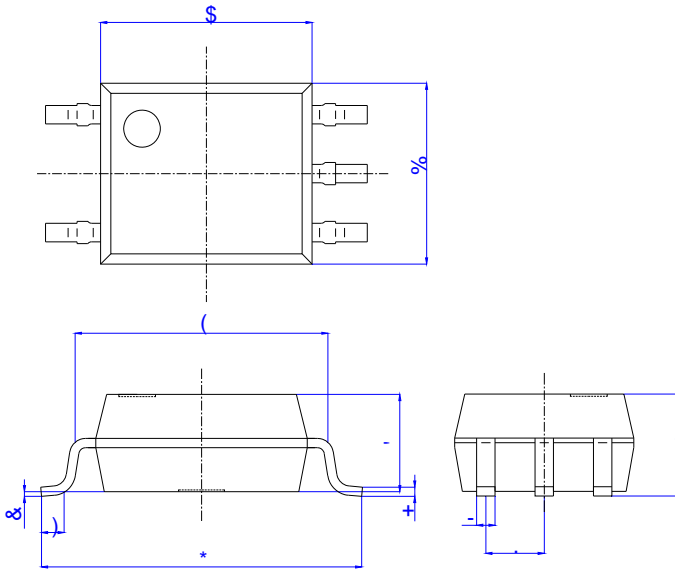

5HI	'LPHQVLRQV					
	0LOOLPHWHUV			,QFKHV		
	0LQ	7\S	0D[0LQ	7\S	0D[
\$						
%						
&						
'						
(
)						
*						
+						
,						
-						
.						

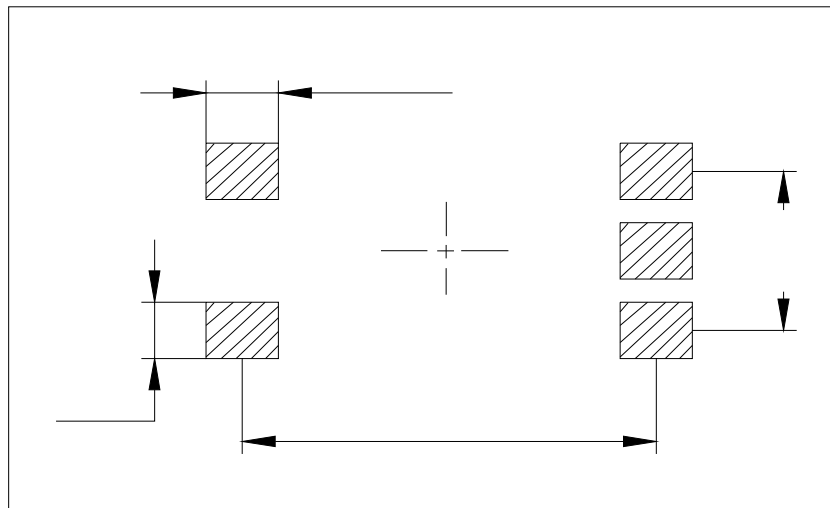

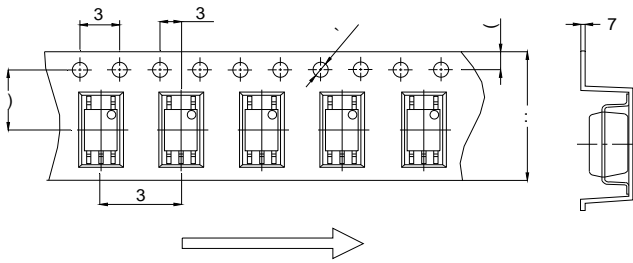

5 HI	'LPHQVLRQV					
	0LOOLPHWHUV ,QFKHV					
	0LQ	7\S	0D[0LQ	7\S	0D[
'						
3						
3						
3						
(
)						
7						
:						

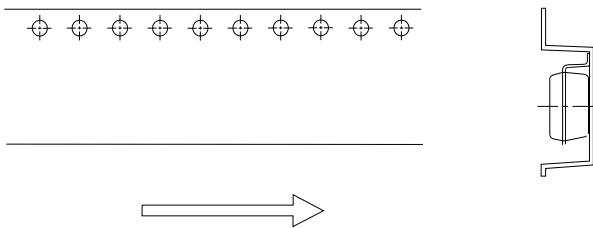

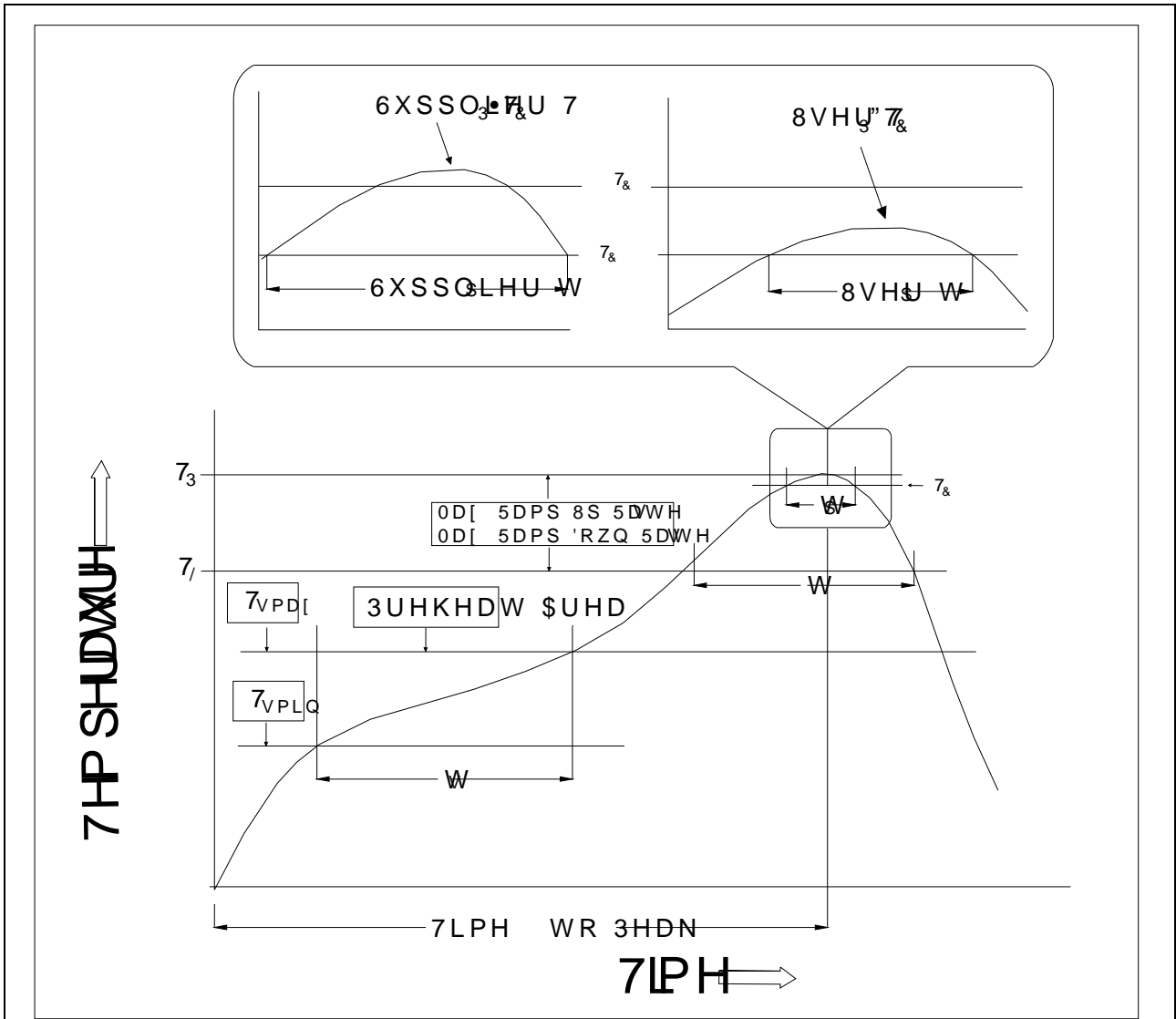

7HP SHUDWXUH 0LQ	7VPLQ	
7HP SHUDWXUH 0D[7VPD[
7LPH WV IURP 7VPLQ WR 7VPD[VHFRQGV
5DPS XS 5DWH W/ WR W	VHFRQG PD[VHFRQG PD[
/LTXLGXV 7HP SHUDWXUH 7/		
7LPH W/ 0DLQWDLQH \$ERYH 7/		VHFRQGV
3HDN %RG\ 3DFNDJH	7HP SHUDWXUH	
7LPH W3 ZLWKLQ		VHFRQGV
5DPS GRZQ 5DWH 73 WR	VHFRQG PD[VHFRQG PD[
7LPH WR 3HDN 7HP SHUDWXUH		PLQXW HV PD[



1RWH

5HIORZ VROGHULQJ LV UHFRPPHQGHG/ DWRZKH QHPSHWDWWDQW DQW
\$YRLG GLUHFV FRQVHDVSRPHQZDQWXRUDFRU H[FHHGLQJ LWV PD
VWRUDJH WHPSHUDWXUH

\$SSOLFDWLRQ RKHSURVXENRQLVLSOHGDDWHG WHPSHUDWXUHV ,QV
VFHQDULRV DQHPSSOLHGWRHFFHHG 1

(QVXUH WKH FRPSRQHGW KDV FRROHG SURPHQVHQDQWLRVSHUDXHQ
PDQXIDFWXULQJ VWHSV

7KH FRPSRQHGW KDV BQKHODUZKHQVWDQGHGKFRQGLWLRQV

5HFRPPHQG VWRUDJH 7HPS a f&

5HFRPPHQG VWRUDJH KXPLGLW\

06/ OHYHO 06/

,QIRUPDWLRQ IXUQXPHQW ILQ WKOLHGRHG WR EH DFFXUDWH D
-LDQJVVX -LH-LH 0LRRHOWHGWDVROLFFVQLRVUHRUSRQHLERQVHT
RI XVH ZLWKRXW FRQVLGHUDWLRQ IRG MWFKQIRUPDWRQRQ
LQ WKLV GRFXPHQW LQJYXZLWHFRXWRQRWLFH DSDUW IURP V
VLJQHG -LDQJVVXOLHVLZILFRKPWKH DJUHHPHQW

3URGXFVW DQG LQIRUPDWLRQ SURYLGHG LQPHQWVRGSRFXPH
-LDQJVVX -LH-LH DVVXIPHLOQW\URVSRQVLQIULQJHPHQW RI RW
ZKLFK PD\ UHVXOW IURP WKH XVH RI VXLK SURFXPHQW DQGS HL
DQG UHSODFHV DOO LQIRUPDWLRQ SUHYLRXVO\ VXSSOLHG

 LV D UHJLVWHUHGDQWJDXGLPHDUNRUF-URHOWHG WURQLFV & R
&RS\ULJKW -LDQJVVX -LH-LH QLVRRHOWHGUSOODHG LJKWV UHVH