



- , (- , (0 , & 5 2 (/ (& 7 5 2 1 , & 6 & 2

/ 7

- 2 & + \$ % / ; 6 H U L H V

5HY \$

^ Z / W d / K E W

7KH SURGXFWV D K H S H P G R S W R F R X S O H U V L Q W K H
 / 6 2 3 D Q G / 6 2 3 : S D F N G H M L F K H F R Q V L V W V R I D K L J K
 H I I L F L H Q W \$ O * D \$ V ' L R J K H W D (P G W D W K L Q J K V S H H G R S W L F D O
 G H W H F W R U 7 K L V G H F V H L O O H S O V R \$ L G E I Q G ' & L V R O D W L R Q
 E H W Z H H Q W K H L Q S X H W D R Q G W R X I W R S S W R F R X S O H U 7 K H
 R X W S X W R I W K H R S D W L X F D I O V G D H Q V R S W G W F R O O H F W R U 6 F K R W
 F O D P S H G W U D Q V L V W R U 7 K H H Q D E O H I X Q F W L R Q D O O R Z V W
 G H W H F W R U W R E H V W U R E P 0 € (K % p 0

0 W S X L T 7 K K H „ @ ° q X ° € W J K @ < R ð K B ð € Z p € 0

- 2 & + \$ %



-LH-LH 0LFURHOHFWURQL

^K>hd D y/DhD Z 7H/ESAUDWXUH f &

3DUDPHWHU	6\PERO	9DOXH
-----------	--------	-------

8QL

	,VRODWLRQ 5HVLVWDQFH	5,62	'& 9 a 5 +				
)ORDWLQJ &DSDFLWDQFH	&,2	9 0+]				S)
6ZLWFKLQJ &KDUDFWHULVWLFV	7ULJJHU /(' &XUUHQW	,)7	9&& 9 92 92/				P\$
	3URSDJDWLRQ 'HOD\ 7LPH WR /RJLF /RZ	W/	& S)				QV
	3URSDJDWLRQ 'HOD\ 7LPH WR /RJLF +LJK	W+	5/				P\$
	3XOVH ZLGWK GLVWRUWLRQ	3W 3W+	,) P\$				QV
	&RPPRQ 0RGH 7UDQVLHQW ,PPXQLW\ DW /RJLF +LJK	&0+	9&& 9 ,) P\$ 9&0 9 5/				N9 V
	&RPPRQ 0RGH 7UDQVLHQW ,PPXQLW\ DW /RJLF /RZ	&0/	9&& 9 ,) P\$ 9&0 9 5/				N9 V
	5LVH 7LPH	WU	& S) 5/				QV
)DOO 7LPH	WI	,) P\$				QV

Z }uu v K%o Œ š]vP }v]š]}v•

&KDUDFWHULVWLFV	6\PERO	0LQ	7\
2SHUDWLQJ 7HPHUDWXUW			
6XSSO\ 9ROWDJH	9&&		9
/RZ /HYHO ,QSXW &XUUHQW			\$
+LJK /HYHO ,QSXW &XUUHQW			\$

- 2 & + \$ %

 -LH-LH 0LFURHOHFWURQL



2XWSXW 3XOO XS 5HVLVW/RU				N	
)DQ 2XW/ DW SHU FKDQQHO	1				77/ /RDGV

KZ Z/E' /E&KZD d/KE

<p>- 2 & + \$ %</p> <p>-LH-LH 0LFURHOHFWURQLFV &R /WG</p> <p>2SWR &RXSOHU</p> <p>+LJK VSHHG</p> <p>6LQJOH 2&</p> <p>9 9& 9</p>	<p>1RQH 7 5 7</p> <p>1RQH /623 : /623 :</p> <p>0%G KLJK VSHHG</p> <p>P\$</p>	%
--	--	---

W I]vP Yμ vš]šÇ	
K% š]]v	Yμ vš]šÇ
E}v IZ	ïïï hv]š•IZ o

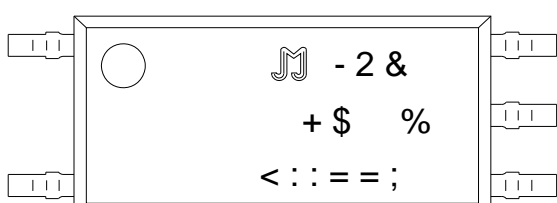
D Z</E'

 <p> - 2 & + \$ % <::==;</p>	<p><u>YWWZZX</u></p> <p>— /27 12</p>
---	--------------------------------------

Z Œ š Œ]•š] • μŒÀ •

),* +LJK /HYHO 2XWSXW &XUUHQW, YV+\$PELHQW 2XWSXW &XUUHQW
7HP SHUDWXUH 7HP SHUDWXUH

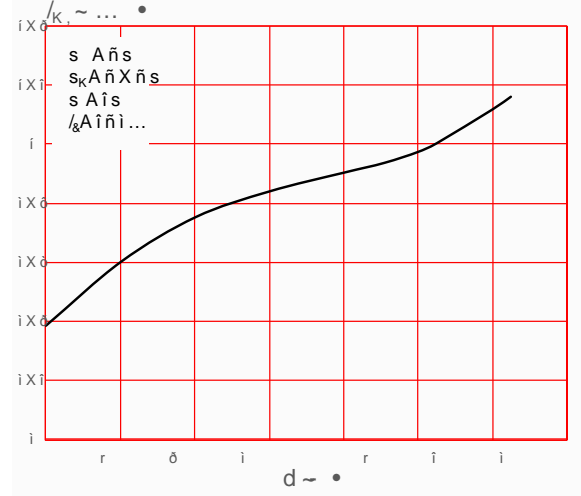
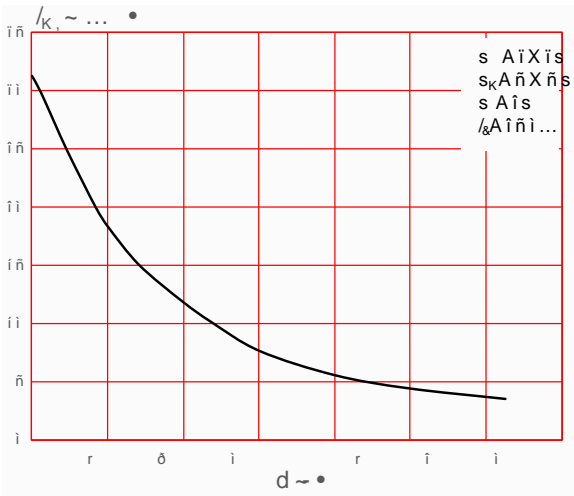

),* ,QSXW 7KUHVCWOG & \$PELHQW),* ,QSXW 7KUHVCWOG & \$PELHQW
7HP SHUDWXUH 7HP SHUDWXUH

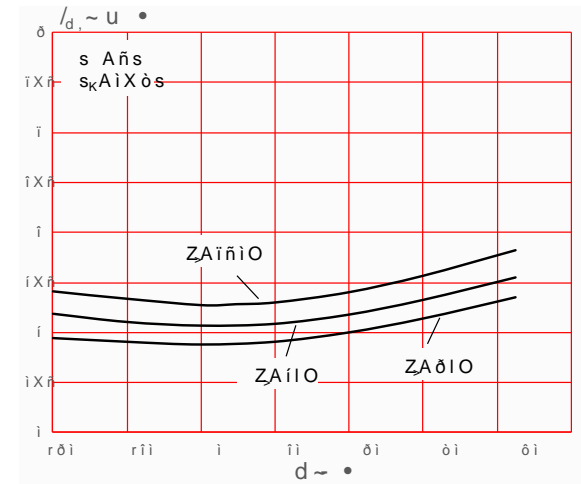
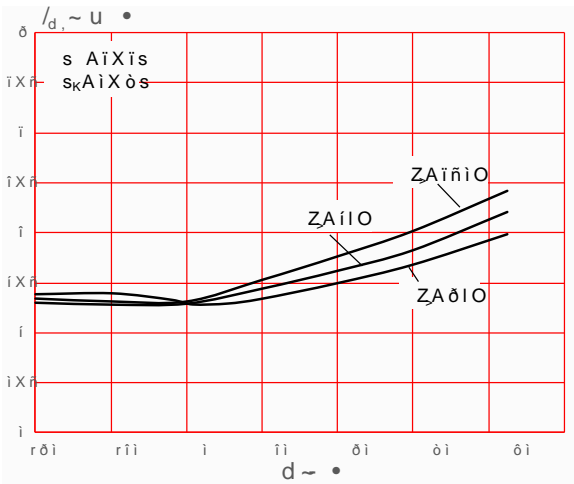

),* /RZ /HYHO 2XWSXW 9ROWDJH \$PELHQW
7HP SHUDWXUH 7HP SHUDWXUH

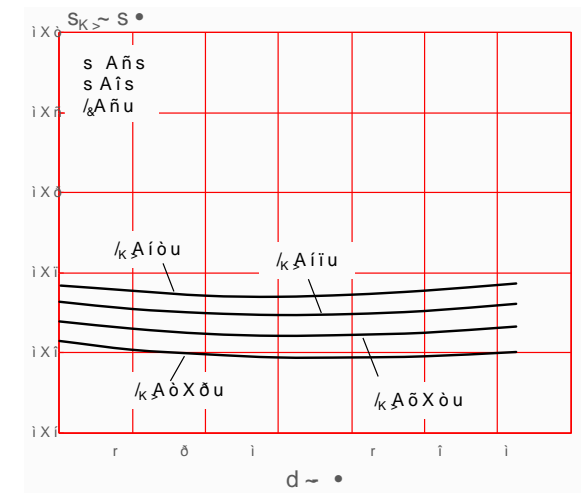
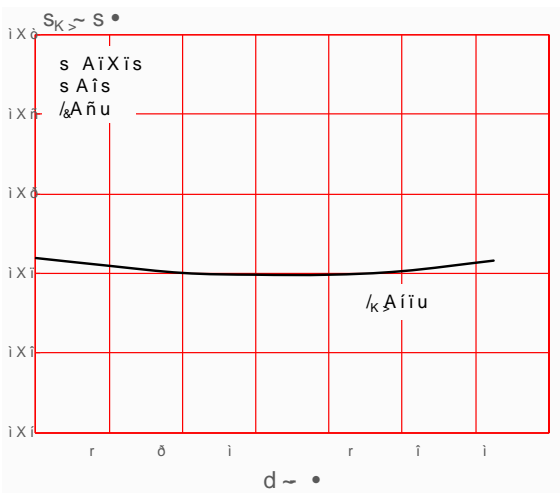

- 2 & + \$ %



-LH-LH 0LFURHOHFWURQL

), * /RZ /HYHO 2XWSXW &XUUHQW Y,Y* \$/RZLHQMO 2XWSXW &XUUHQW
7HP SHUDWXUH 7HP SHUDWXUH

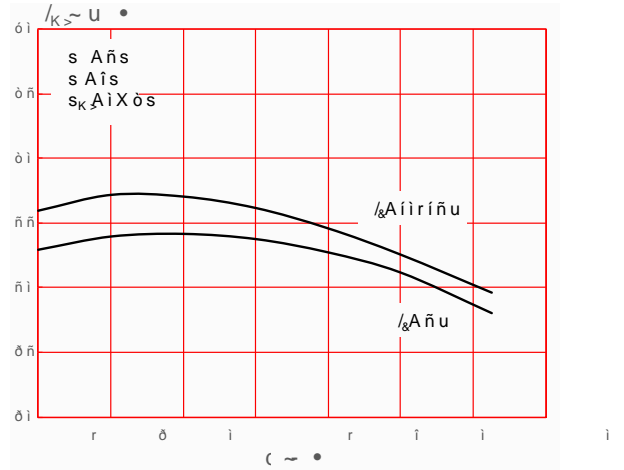
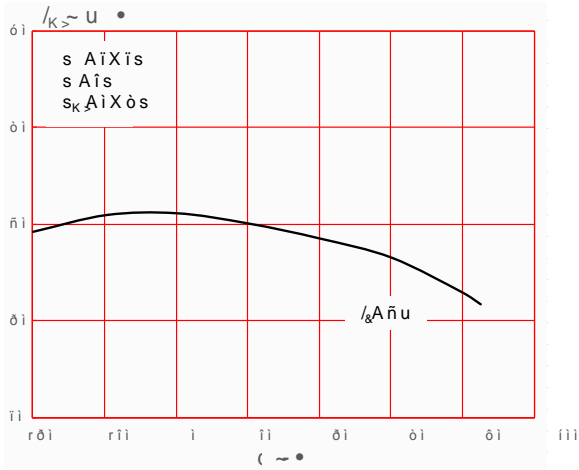

), * , QSXW)RUZDUG 9ROWDJH YV)Q* SXWR URZDUG 9ROWDJH YV \$PELH
&XUUHQW 7HP SHUDWXUH

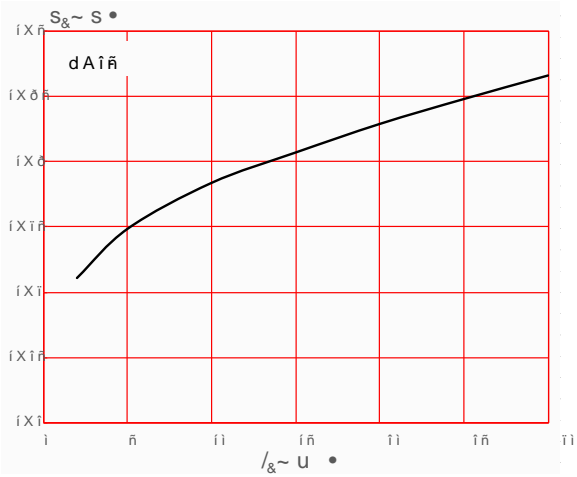

A î ñ



),* 3XOVH :LGWK 'LVWRUWLRQ YV), \$PELHQW :LGWK 'LVWRUWLRQ Y
7HPSHUDWXUH 7HPSHUDWXUH

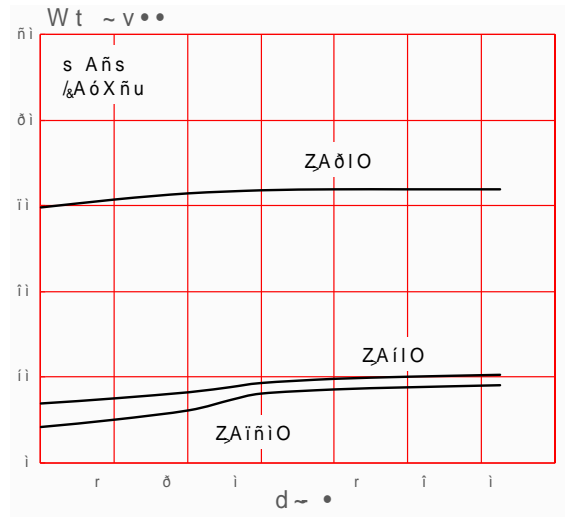
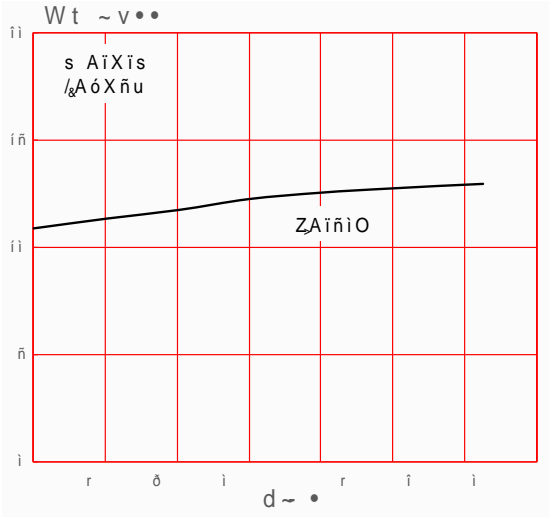

d ^d /Z h/d^

)LJ 6ZLWFKLQJ 7LPH 7HVW &LUFXLW DQG :DYHIRUP

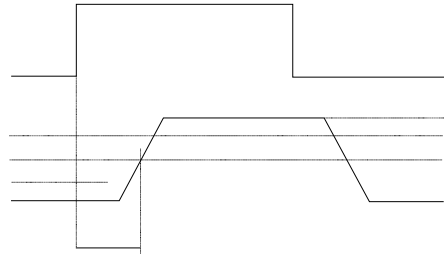
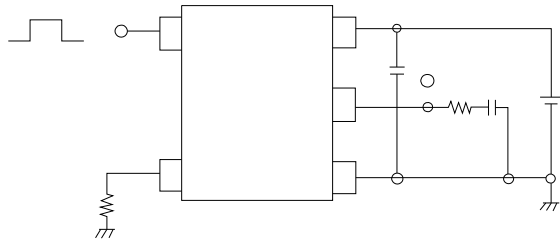

- 2 & + \$ %

W I P]u v •}]v ~hv]šW uu•

> ^KWñ

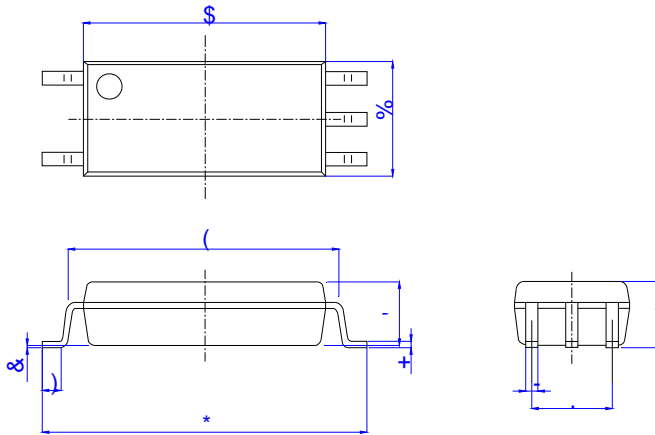

5HI	'LPHQVLRQV					
	0LOOLPHWHUV ,QFKHV					
	0LQ	7\ S	0D[0LQ	7\ S	0D[
\$						
%						
&						
,						
(
)						
*						
+						
,						
-						
.						

> ^KWñt

'LPHQVLRQV
 5HI 0LOOLPHWHUV ,QFKHV
 0LQpÄ0LWP• @ Ä x 0L p•°00 •`g€!°0L WP•@@R s0L0L#Ä0

Z KDD E ^K> Z D ^< ~]u v•]}v•]v uu μvσ •• }šZ Œ

> ^KW ñ

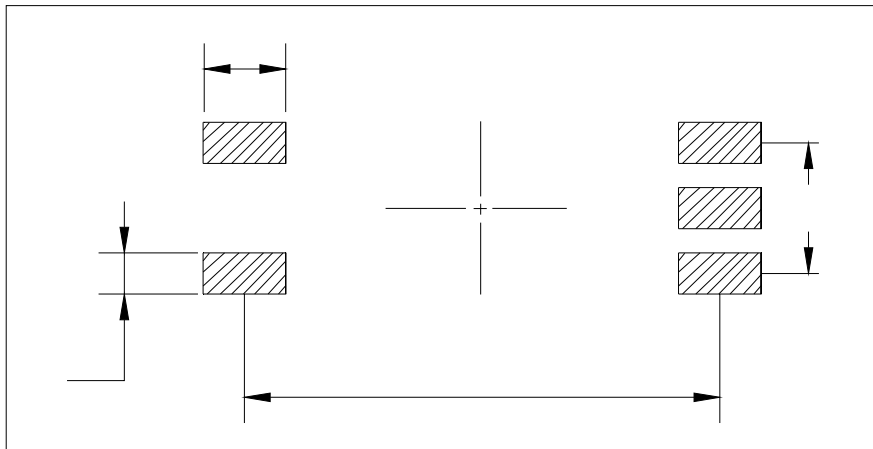

> ^KW ñ t

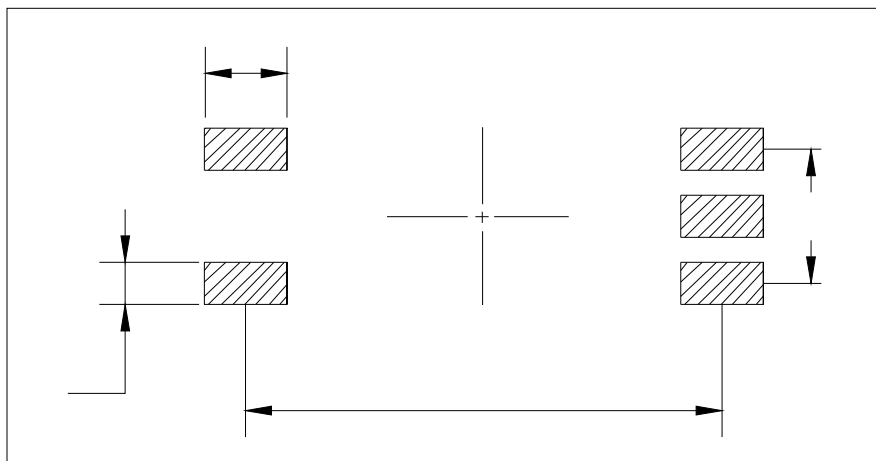

- 2 & + \$ %



- LH-LH 0LFURHOHFWURQL

ZZ/ Z d W ^W /&/ d/KE ^ }v]uu μνo •••ššž ĆÁ]•

K%o š]}v E}v IZ

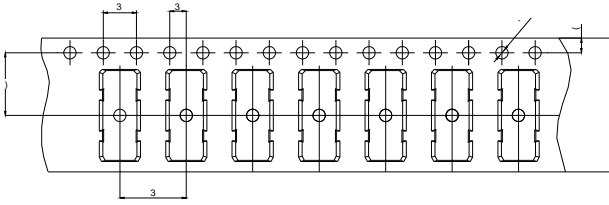

5HI	'LPHQVLRQV					
	0LOOLPHWHUV ,QFKHV					
	0LQ	7\ S	0D[0LQ	7\ S	0D[
'						
3						
3						
3						
(
)						
7						
:						

Z >Kt /E&KZD d/KE

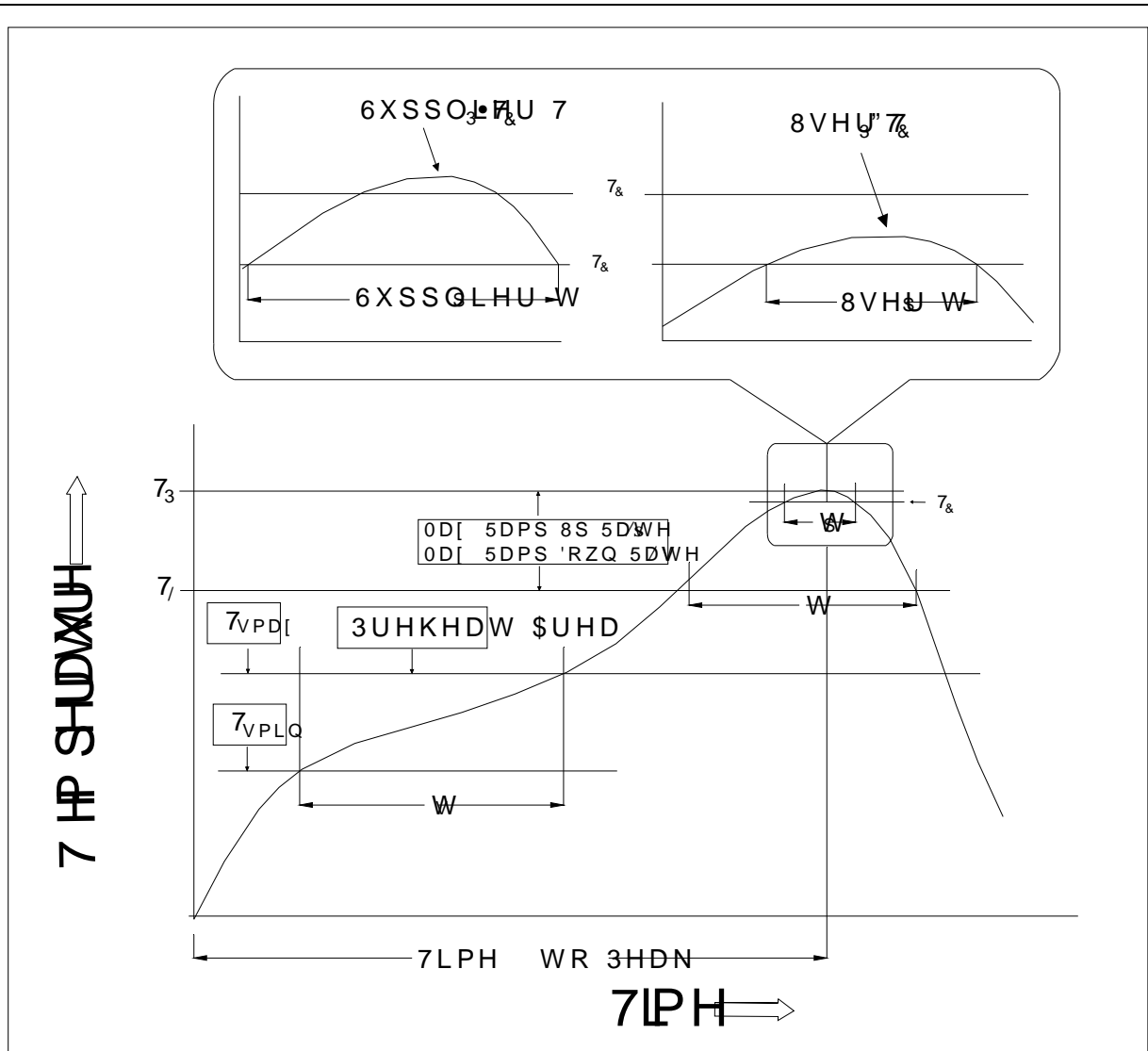

3URILQH)HDWXUH 3E \$VVHPEO\	3URILQH 3E)UHH \$VVH
7HP SHUDWXUH 0LQ 7VPLQ	
7HP SHUDWXUH 0D[7VPD[
7LPH WV IURP 7VPLQ WR 7VPD[VHFRQG V
5DPS XS 5DWH W/ WR W3/HFRQG PD[VHFRQG PD[
/LTXLGXV 7HP SHUDWXUH 7/	
7LPH W/ 0DLQWDLQH \$ERYH 7/	VHFRQG V
3HDN %RG\ 3DFNDJH 7HP SHUDWXUH	
7LPH W3 ZLWIKLQ	VHFRQG V VHFRQG V
5DPS GRZQ 5DWH 73 WR 7VHFRQG PD[VHFRQG PD[
7LPH WR 3HDN 7HP SHUDWXUH	PLQXWHV HV PD[

1RWH

- 2 & + \$ %



- LH - LH 0LFURHOHFWURQL

5HIORZ VROGHULQJ LV UHFRPPHQGHG/ DWRVZKH QVHPSWKUDWVXUWHFHDV
\$YRLG GLUHFV FRQVHDIFSRPHFRZOHQWRXUODFRU/ H[FHHGLQJ LWV PD
VWRUDJH WHPSHUDWXUH

\$SSOLFDFWLRQ RKHSHSRVXENRQLWLSOHGDDWHG WHPSHUDWXUHV ,Q V
VFHQDULRV DQHPSVOLHQRWRHFFHHG 1

(QVXUH WKH FRPSRQHQW KDV FRROHG WRDFHEWKOQZLHRSVHWDVHQL
PDQXIDFWXULQJ VWHSV

7KH FRPSRQHQW KDRM BQMKHODUQZKHQVWRDGHGKGRQLGLWLRQV

5HFRPPHQG VWRUDJH 7HPS a f&

5HFRPPHQG VWRUDJH KXPLGLW\

06/ OHYHO 06/

,QIRUPDWLRQ IXUQXPHQW/ LQ WKOLHGRHG WR EH DFFXUDWH D
-LDQJVVX -LH-LH 0LFRURHOHFWG WDRVOLFHVVQLRVUHRVSRQVHLERQVHT
RI XVH ZLWKRXW FRQVLGHUDWLRQ IRG MWFKQIQURPDVWLRQ
LQ WKLV GRFXPHQW LQJYXZLWVFRXWRQRWLFH DSDUW IURP V
VLJQHGH -LDQJVVXOLHVLZILFRKPKKH DJUHHPHQW

3URGXFVV DQG LQIRUPDWLRQ SURYLGHG LQPHQWVRGSDXPH
-LDQJVVX -LH-LH DVVXIPHLOQR\URVSRQVLQIULQJHPPHQW RI RW
ZKLFK PD\ UHVXOW IURP WKH XVH RI VFKLW SURFXPHQW DQGS HL
DQG UHSODFHV DOO LQIRUPDWLRQ SUHYLRXVO\ VXSSOLHG



LV D UHJLVWHUHGDQJUDXGHPDUNRUFURHOHFWWURQLFV &R
&RS\ULJKW -LDQJVVX -LH-LH 0LFRURHOHFWGUSPQDGLJKWV UHVH

'RFXPHQW 5HJLVLRQ +LVWRU\