

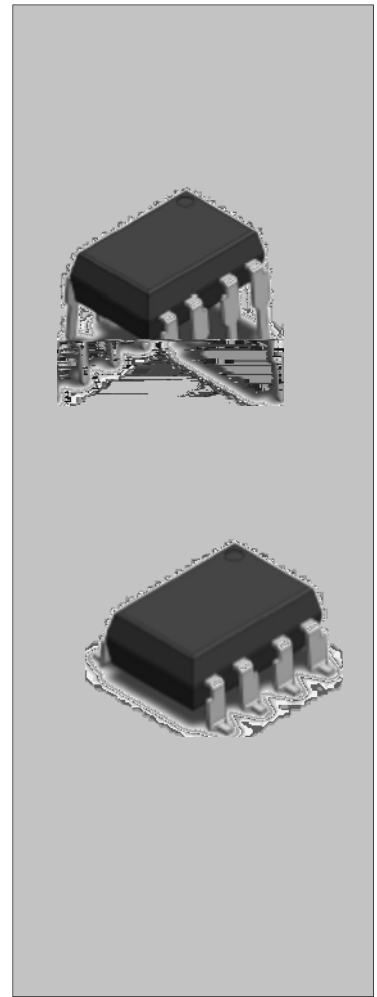

DESCRIPTION:



MAIN FEATURES

Schematic

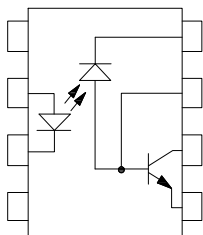

JOCHA21B D8P/S

1RWH 9% 'HIDXOW 1&

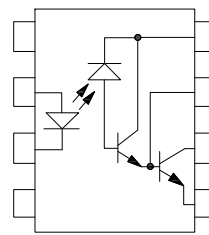

JOCHA21E D8P/S

Truth Table

			→				
			→				

ORDERING INFORMATION

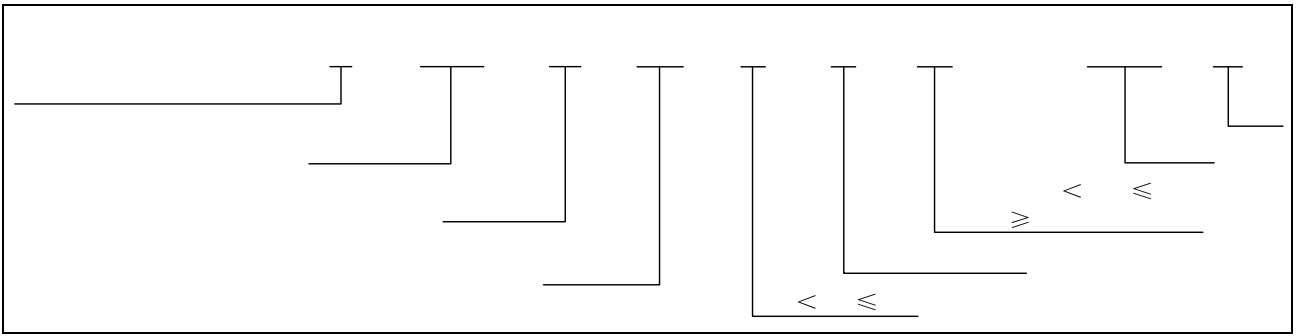

Packing Quantity	
Option	Quantity

MARKING

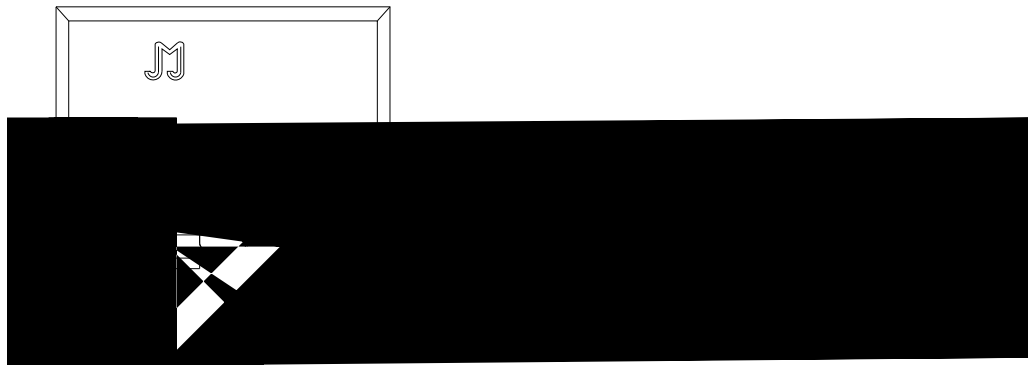

Characteristics Curves

FIG.1:

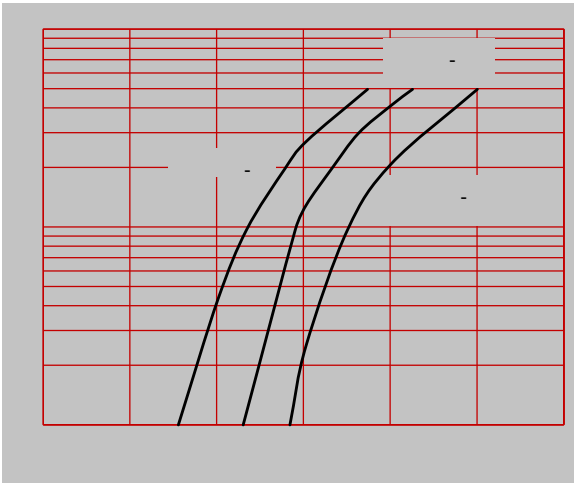

FIG.2:

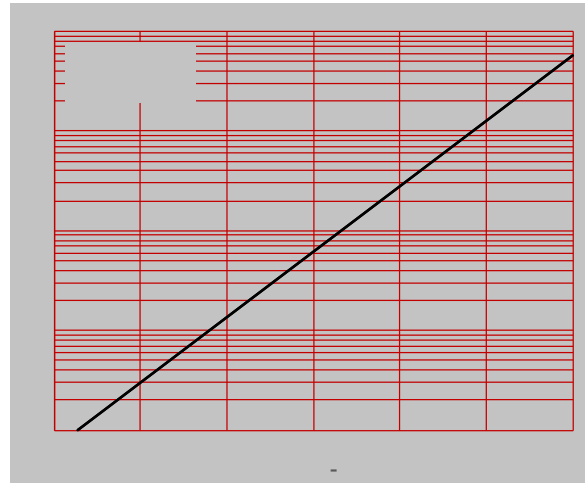

FIG.3:

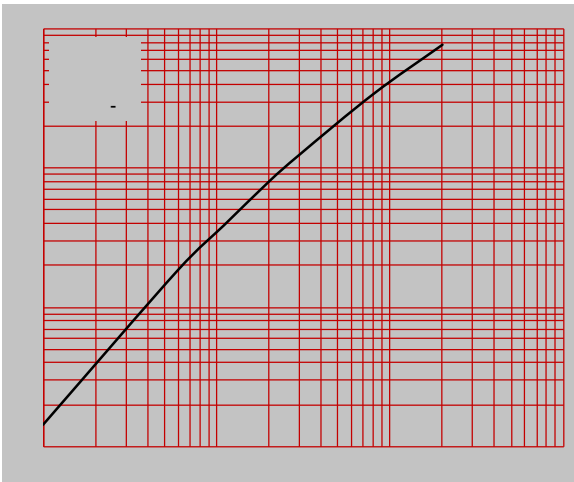

FIG.4:

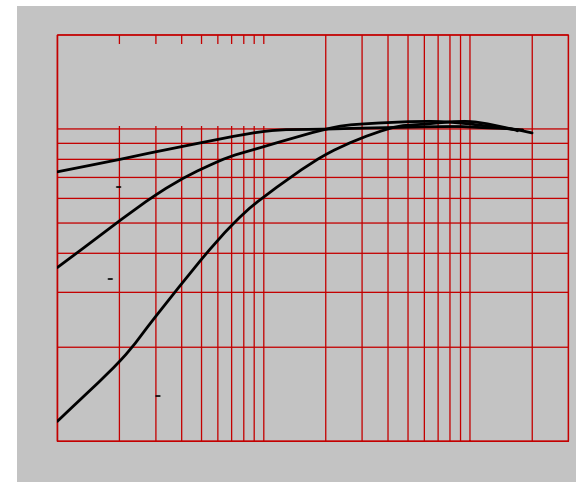

FIG.5:

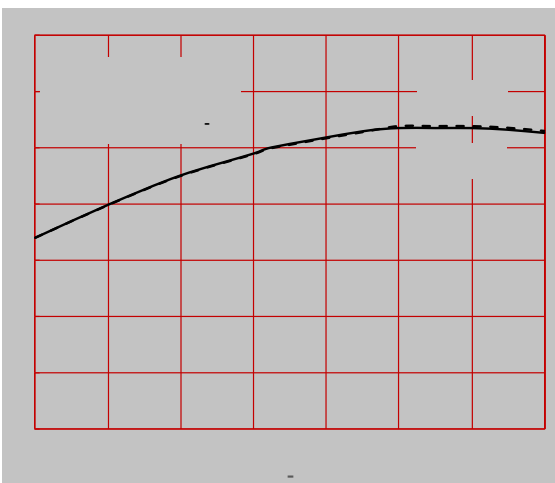

FIG.6:

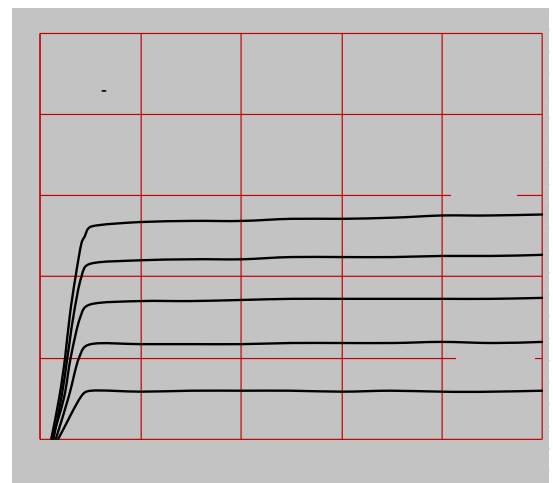

FIG.7:

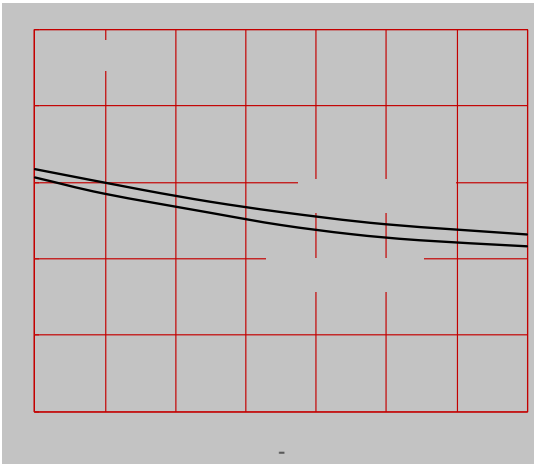

FIG.8:

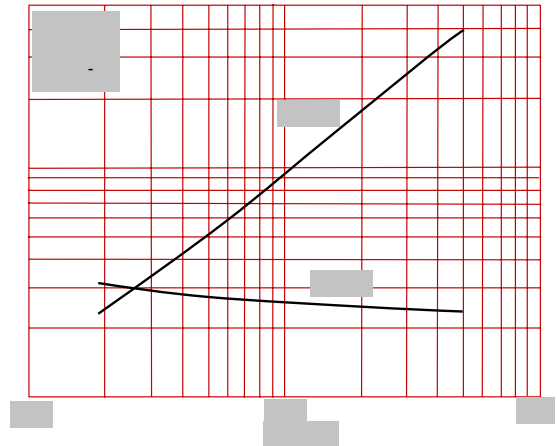
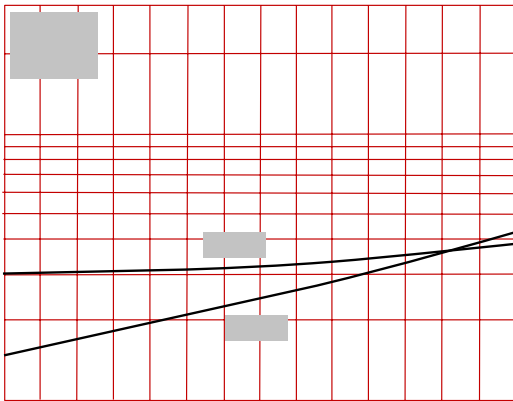

FIG.9:



TEST CIRCUITS

Fig.10: Switching Time Test Circuit and Waveform

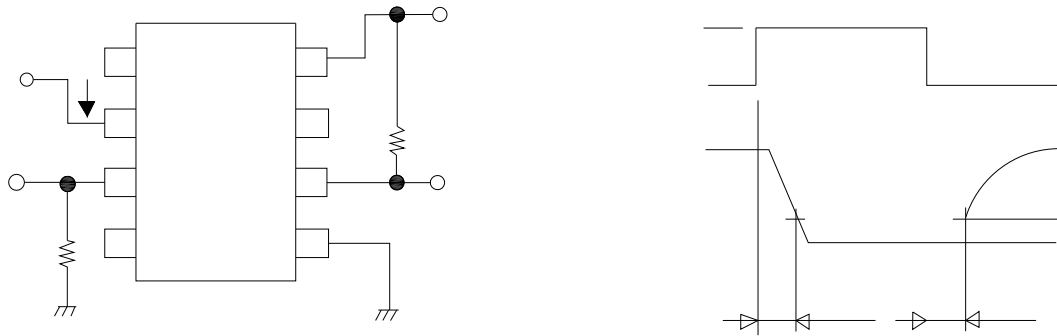
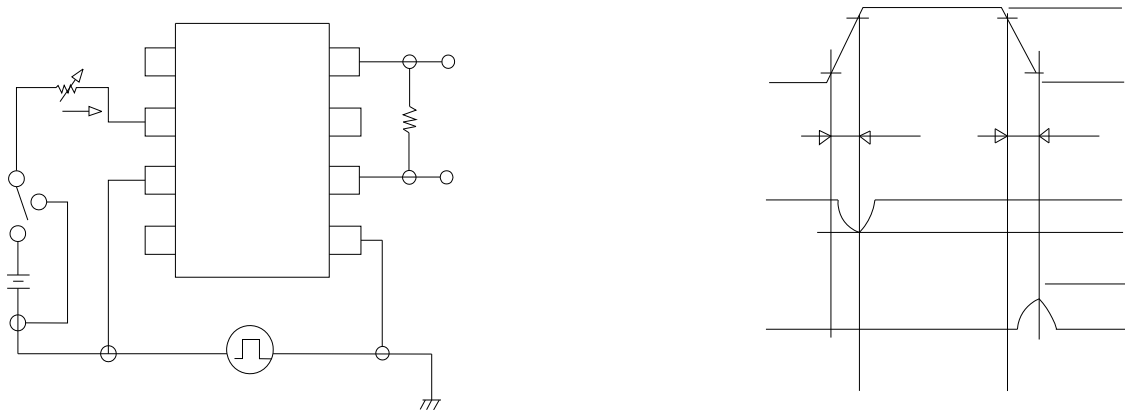
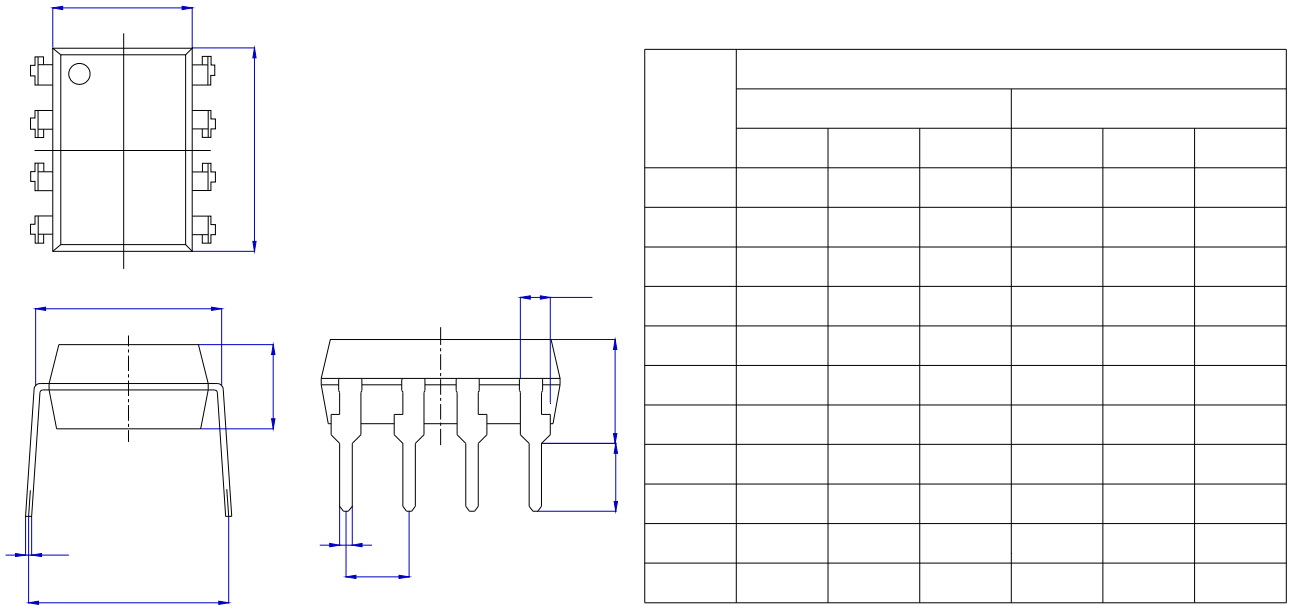

Fig.11: CMTI Test Circuit and Waveform



Package Dimension (Unit: mm)

Standard DIP Type:



Option SMD Type:

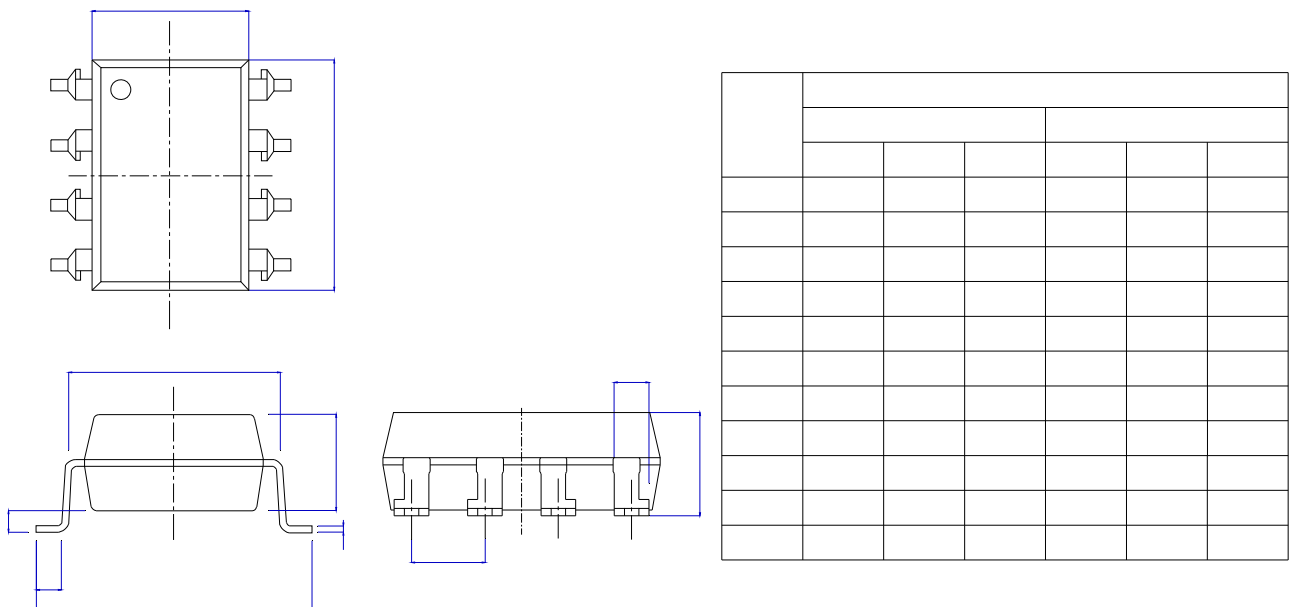

RECOMMENDED SOLDER MASK (Dimensions in mm unless otherwise stated)

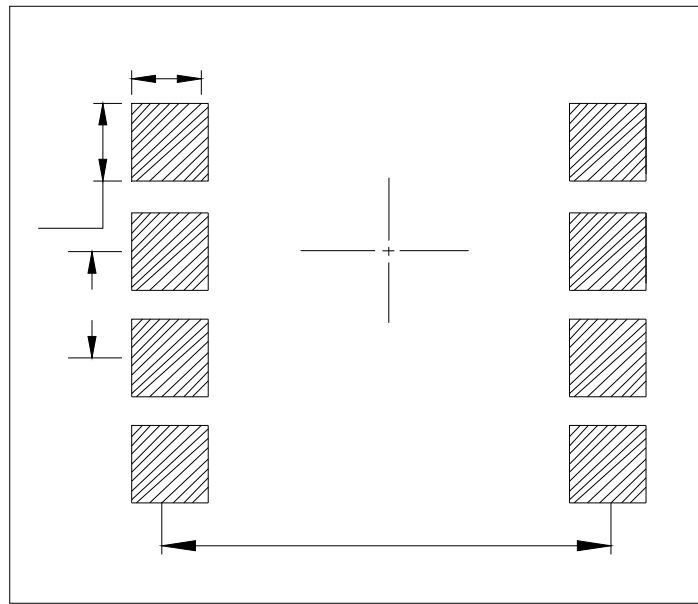

TUBE SPECIFICATIONS (Dimensions in mm unless otherwise stated)

Standard DIP

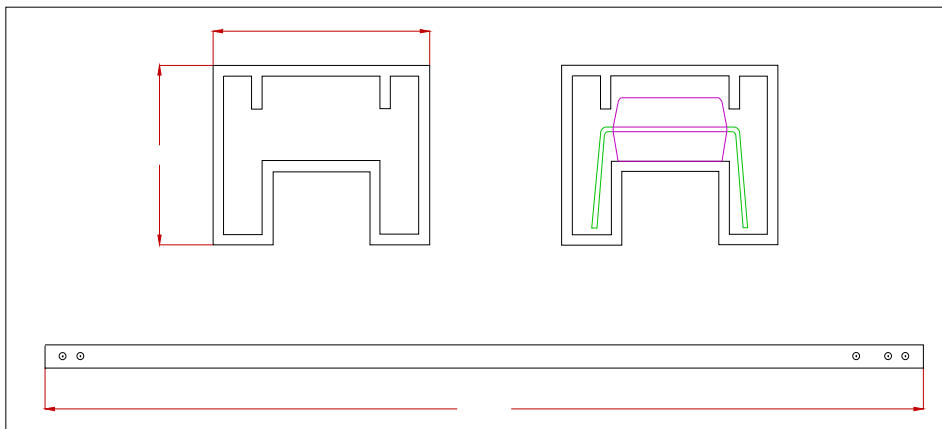

WAVE SOLDERING

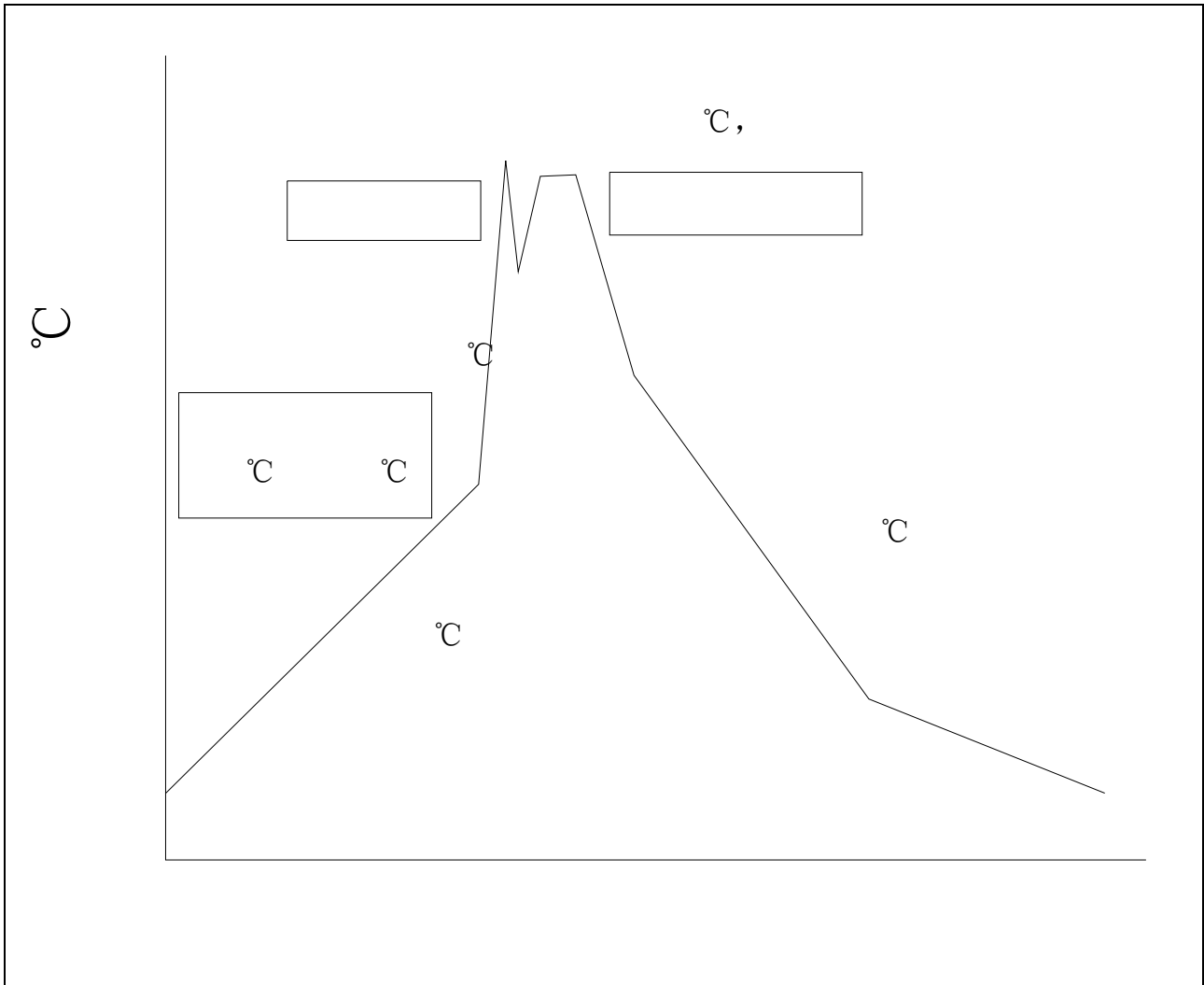

HAND SOLDERING BY SOLDERING IRON	
	\pm °C

JOCHA21X