



JOCHB14B-S8

Rev.A.1.0

DESCRIPTION:

The products are 10MBd high-speed opto-couplers in a plastic SOP8 package. The device consists of a high efficient AlGaAs Light Emitting Diode and a high speed optical detector. This design provides excellent AC and DC isolation between the input and output sides of the optocoupler. The output of the optical detector features an $w \hat{A}$

high o s dm

	Reverse Voltage	V_R	6	V
	Input Power Dissipation	P_D	100	mW
Output	Supply Voltage	V_{CC}	7	V
	Output Voltage	V_O	7	V
	Output Current	I_O	50	mA
	Output Power Dissipation	P_O	60	mW
Total Power Dissipation		P_{tot}	160	mW
Isolation Voltage		V_{iso}	3750	Vrms
Operating Temperature		T_{opr}	-40~110	
Junction Temperature		T_j	125	
Storage Temperature		T_{stg}	-55~125	
Soldering Temperature		T_{sol}	260	

NOTE1: 100μs pulse, 100Hz frequency

NOTE2: AC for 1minute, R.H.=40~60%

ELECTRICAL CHARACTERISTICS (Temperature=25°C)

Parameter		Symbol	Condition	Min.	Typ.	Max.	Unit
	Forward Voltage	V_F	$I_F=10mA$	-	1.35	1.6	V
	Reverse Current		$V_R=6V$	-	-	1	μA
	Input Capacitance		$V_I=0, f=1MHz$	-	60	-	pF
Output	High Level Output Current	I_{OH}	$I_F=250\mu A,$ $V_{CC}=5.5V,$ $V_O=5.5V$	-	5.5	100	μA
	High Level Supply Current	I_{CCH}	$V_{CC}=5.5V,$ $I_F=0mA$	-	-	15	mA

Output

Switching Characteristics	Trigger LED Current	I_{FT}	$V_{CC}=5.5V$ $V_O=V_{OL}$	-	-	5	mA
	Propagation Delay Time to Logic Low	t_{PHL}	$C_L=15pF,$ $R_L=350$, $I_F=7.5mA$	-	-	75	ns
	Propagation Delay Time to Logic High	t_{PLH}		-	-	75	ns
	Pulse width distortion	$ t_{PHL}-t_{PLH} $		-	-	35	ns
	Common Mode Transient Immunity at Logic High	CM_H		$V_{O(min.)}=2V,$ $I_F=0mA,$ $V_{CM}=10V_{p-p},$ $R_L=350$	15	-	-
	Common Mode Transient Immunity at Logic Low	CM_L	$V_{O(max.)}=0.8V,$ $I_F=7.5mA,$ $V_{CM}=10V_{p-p},$ $R_L=350$	15	-	-	kV/ μs
	Rise Time	t_r	$C_L=15pF,$ $R_L=350$, $I_F=7.5mA$	-	24	35	ns
	Fall Time	t_f		-	10	25	ns

Recommended Operating Conditions

Characteristics	Symbol	Min.	Typ.	Max.	Unit
Low Level Input Voltage	V_{FL}	0	-	0.8	V
Supply Voltage	V_{CC}	2.7	-	3.6	V
		4.5	-	5.5	
Low Level Input Current	I_{FL}	0	-	250	μA
High Level Input Current	I_{FH}	7	-	20	mA
Output Pull-up Resistor	R_L	330	-	4k	
Fan Out (at $R_L=1k$ per channel)	N	-	-	5	TTL Loads

Characteristics Curves

FIG.1: High Level Output Current vs. Ambient Temperature

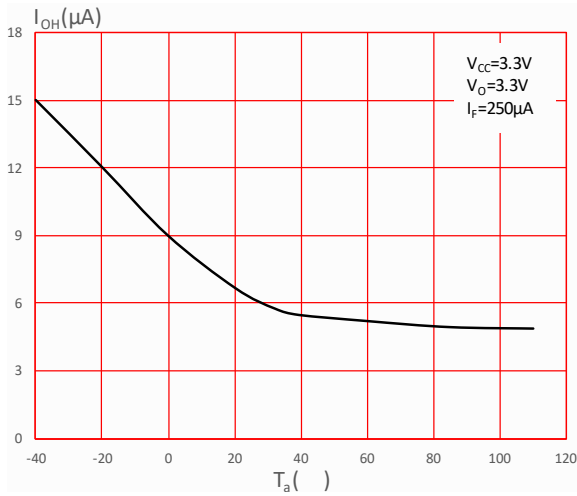

FIG.2: High Level Output Current vs. Ambient Temperature

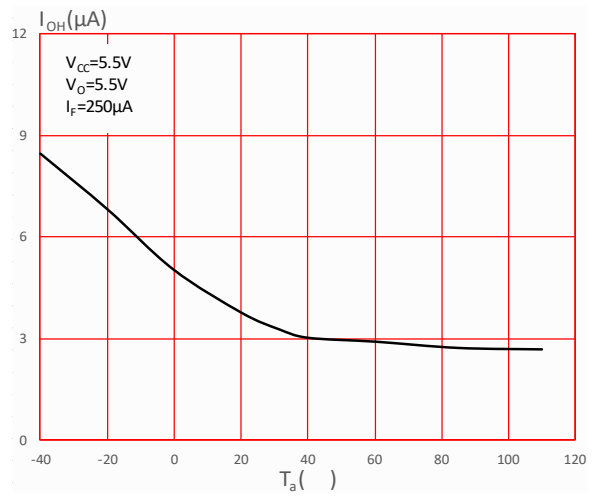

FIG.3: Input Threshold Current vs. Ambient Temperature

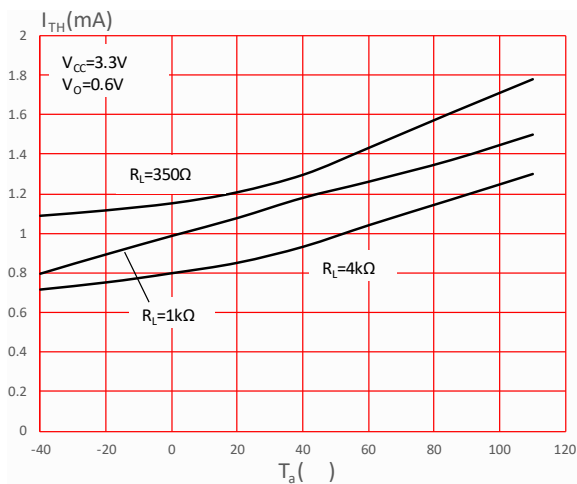

FIG.4: Input Threshold Current vs. Ambient Temperature

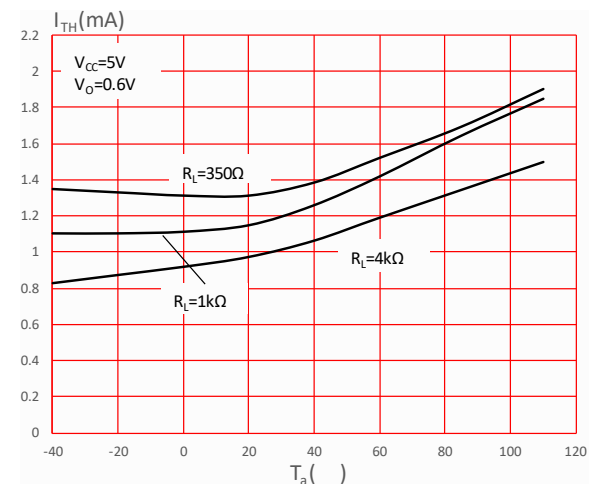

FIG.5: Low Level Output Voltage vs. Ambient Temperature

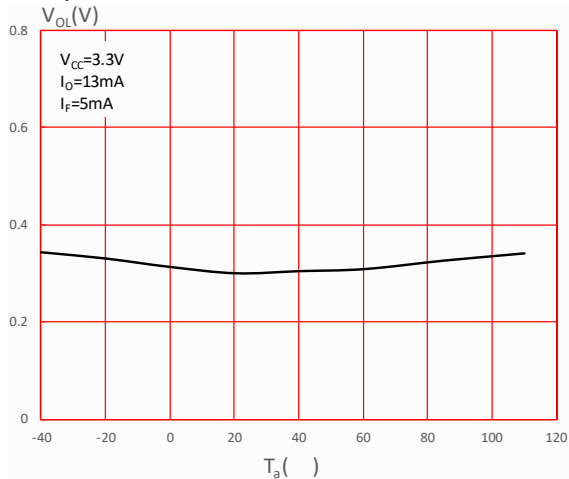

FIG.6: Low Level Output Voltage vs. Ambient Temperature

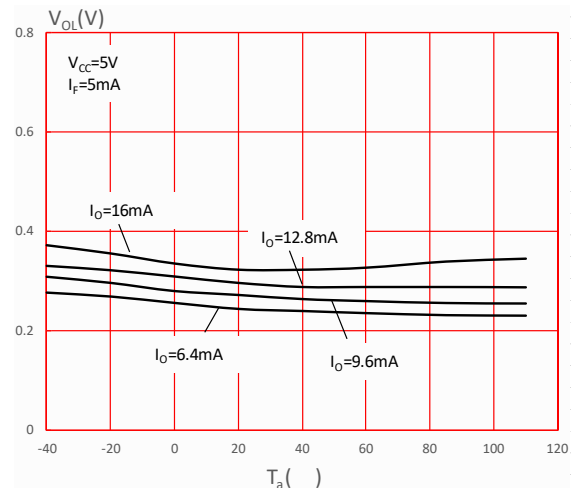

FIG.7: Low Level Output Current vs. Ambient Temperature

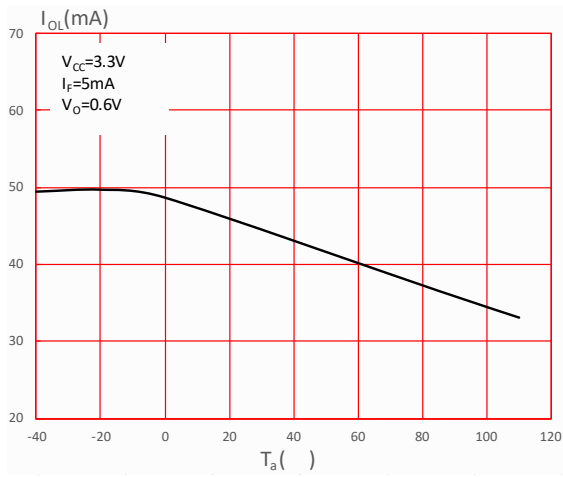
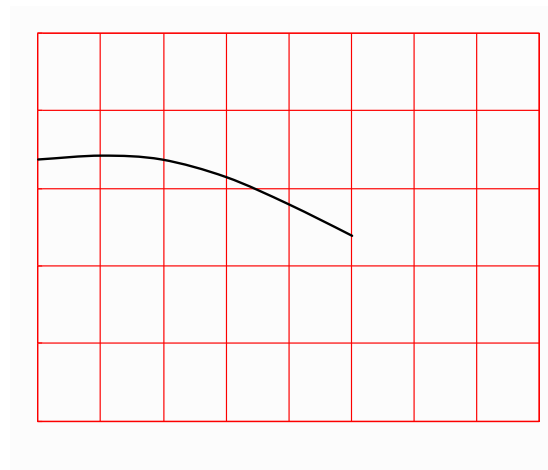
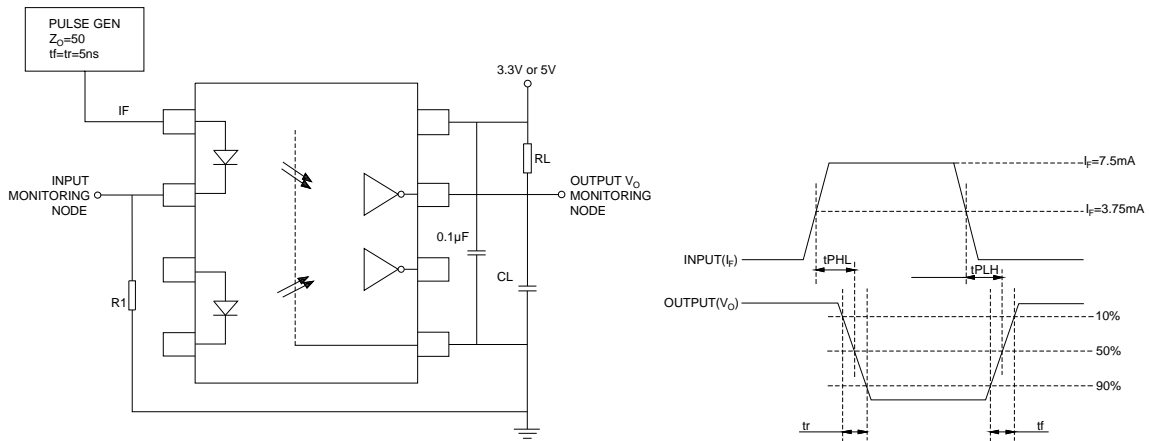

FIG.8: Low Level Output Current vs. Ambient Temperature



TEST CIRCUITS

Fig.13: Test Circuit for TPHL and TPLH



Package Dimension (Unit: mm)

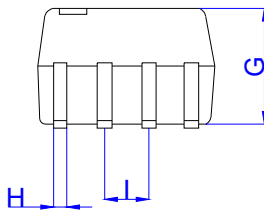
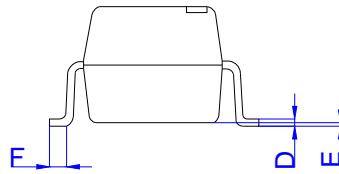
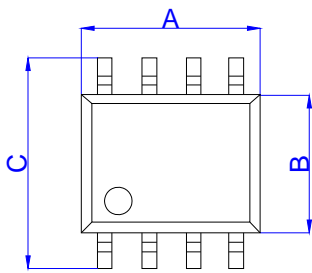

Ref.	Dimensions					
	Millimeters			Inches		
	Min.	Typ.	Max.	Min.	Typ.	Max.
A	4.93		5.33	0.194		0.210
B	3.80		4.10	0.150		0.161
C	5.70		6.30	0.224		0.248
D	0.15		0.25	0.006		0.010
E	0.00		0.20	0.000		0.008
F	0.305		0.50	0.012		0.020
G	3.20		3.40	0.126		0.134
H	0.30		0.50	0.012		0.020
I	1.17		1.37	0.046		0.054

REC

CARRIER TAPE SPECIFICATIONS (Dimensions in mm unless otherwise stated)

Option None

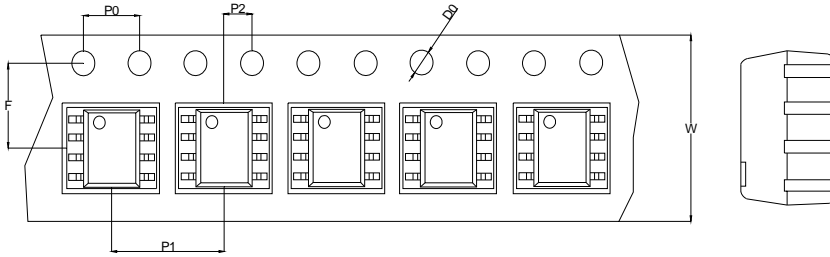

Ref.	Dimensions					
	Millimeters			Inches		
	Min.	Typ.	Max.	Min.	Typ.	Max.
D0	1.40	1.50	1.60	0.055	0.059	0.063
P0	3.90	4.00	4.10	0.154	0.157	0.161
P1	7.90	8.00	8.10	0.311	0.315	0.319
P2	1.90	2.00	2.10	0.075	0.079	0.083
F	5.40	5.50	5.60	0.213	0.217	0.220
W	11.70	12.00	12.30	0.461	0.472	0.484

Option R

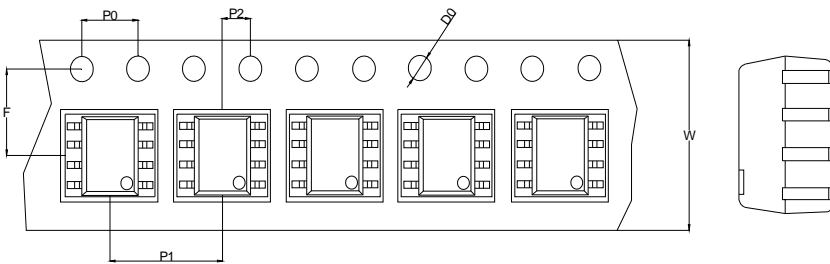

Ref.	Dimensions					
	Millimeters			Inches		
	Min.	Typ.	Max.	Min.	Typ.	Max.
D0	1.40	1.50	1.60	0.055	0.059	0.063
P0	3.90	4.00	4.10	0.154	0.157	0.161
P1	7.90	8.00	8.10	0.311	0.315	0.319
P2	1.90	2.00	2.10	0.075	0.079	0.083
F	5.40	5.50	5.60	0.213	0.217	0.220
W	11.70	12.00	12.30	0.461	0.472	0.484

REFLOW INFORMATION

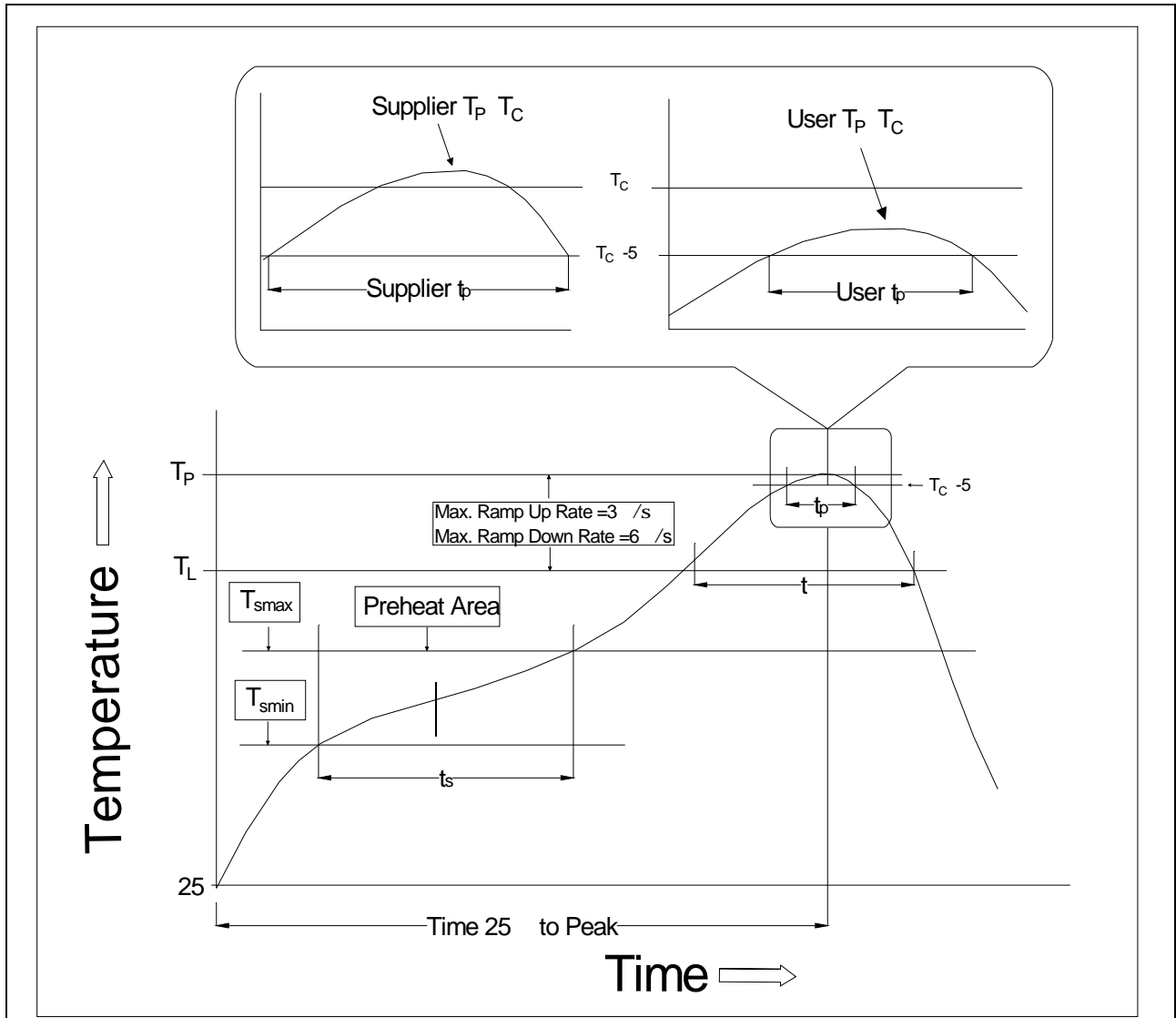

Profile Feature	Sn-Pb Assembly Profile	Pb-Free Assembly Profile
Temperature Min. (T _{smin})	100	150
Temperature Max. (T _{smax})	150	200
Time (t _s) from (T _{smin} to T _{smax})	60-120 seconds	60-120 seconds
Ramp-up Rate (t _L to t _P)	3 °/second max.	3 °/second max.
Liquidus Temperature (T _L)	183	217

Time (t_A) 8- 183 e 183 nds

Note:

1. Reflow soldering is recommended at the temperatures and times shown, no more than three times.
2. Avoid direct contact between the epoxy body and any tools or surfaces exceeding its maximum storage temperature.
3. Application of pressure on the epoxy body is prohibited at elevated temperatures. In specific scenarios, any applied force must not exceed 2.5N.
4. Ensure the component has cooled to ambient temperature before proceeding with any subsequent manufacturing steps.
5. The component has a shelf life of one year when stored under standard conditions.
6. Recommend storage Temp.: 0~40°C;
Recommend storage humidity: <60%;
MSL level: MSL 1

Information furnished in this document is believed to be accurate and reliable. However, Jiangsu JieJie Microelectronics Co., Ltd. assumes no responsibility for the consequences of use without consideration for such information nor use beyond it. Information mentioned in this document is subject to change without notice, apart from that when an agreement is signed, Jiangsu JieJie complies with the agreement.

Products and information provided in this document have no infringement of patents. Jiangsu JieJie assumes no responsibility for any infringement of other rights of third parties which may result from the use of such products and information. This document supersedes and replaces all information previously supplied.

 is a registered trademark of Jiangsu JieJie Microelectronics Co., Ltd.

Copyright © 2026 Jiangsu JieJie Microelectronics Co., Ltd. All rights reserved.