



JOCMA57D-SVS4

Rev.A.1.0

DESCRIPTION:

7KH SURGXFVW DUHODSVQ 7KSWG FDFU LV D YHU\
VPDOO RXWODCHH Q SC RWRUHOD\ VXLWDEOH IRU VXUIDFH PF
DVVHPEO\ ,W FRQVLVWV RI DQ LQIUDUHG /(' RSWLFDQO\ FR
SKRWR 026)(7 DQG LV KRZVHSDEQDJH ,W IHDWXUHV
ORZ RXWSXW FDSDFLWDEQFHID&M)RQRDI VZLWFKLQJ RI
KLJK IUHTXHQF\ VLJQHDOO PDUNVZLWFKLQJ DSSOLFDFWLR
LQ KLJK VSHHG WHVWHWUHW7ZIHGSHORGXWHG LQ DXWRPDWL
WHVW HTXLSPHQW KLWVWSHHHG KRJKFV,SHHG PHPRU\
WHVWHUV DQG PHDVXULQJ LQVWUXPHQVV

MAIN FEATURES

- ,VRODWLRQ YRDMDJH
2SHUDWLQJ WHPSOHJHWXU& WR f&
5(\$&+ 5R+6 FRPSOLDQFH
+%0 + \$ 00 0 &'0 &
&4& DSSURYHG
9'(DSSURYHG
8/ DSSURYHG

ABSOLUTE MAXIMUM RATINGS SP7HP SHUDWXUH f&

Characteristics Curves

FIG.1: 0D[\$OORZDEOH /(')RUZDUG \$PELHQW 7HPSHUDWXUH

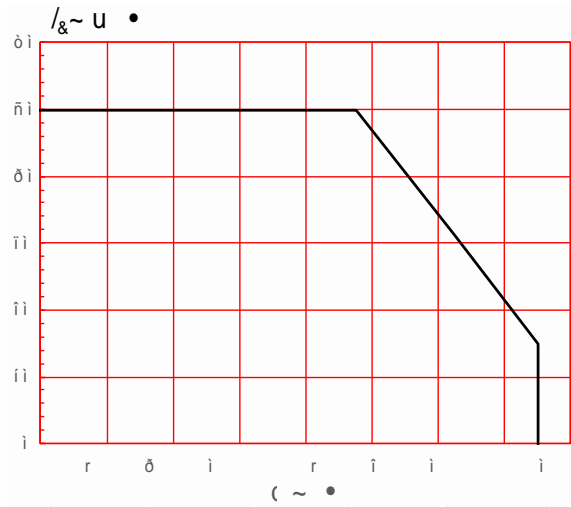

FIG.2: 2QVWYDWH & XUUHQW YV \$PELHQW 7HPSHUDWXUH

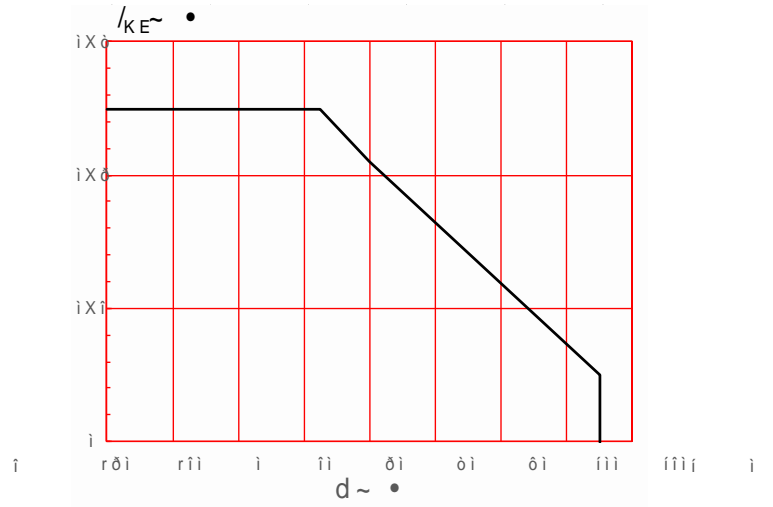

FIG.3: /(')RUZDUG & XUUHQW YV /(' 9ROWDJH

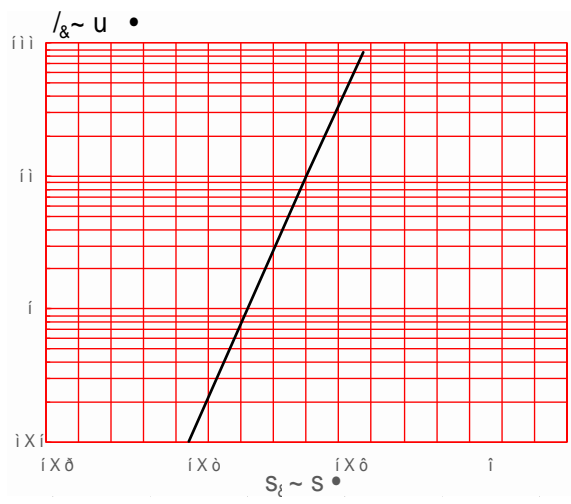

FIG.4: 2QVWYDWH & XUUHQW YV 2QV

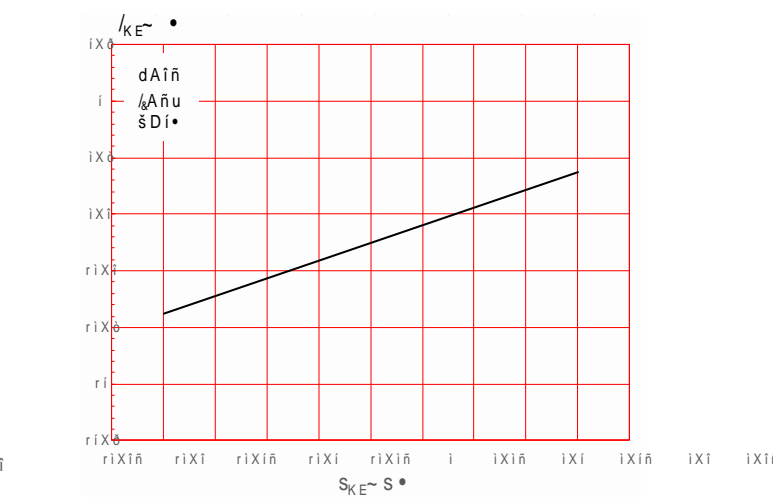

FIG.5: 2Q 5HVLVWYDWH & XUUHQW YV \$PELHQW 7HPSHUDWXUH

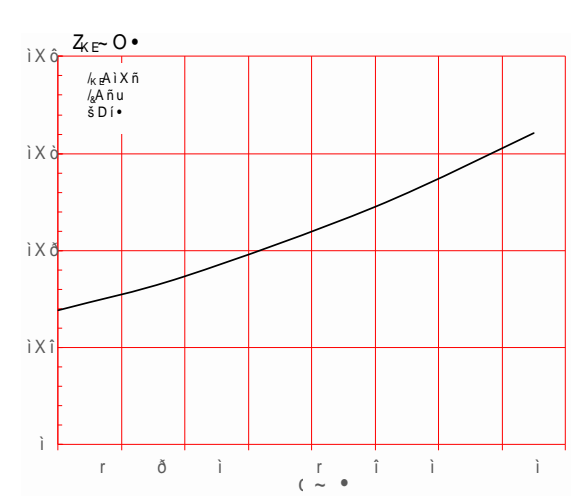

FIG.6: 2QVWYDWH & XUUHQW YV \$PELHQW 7HPSHUDWXUH

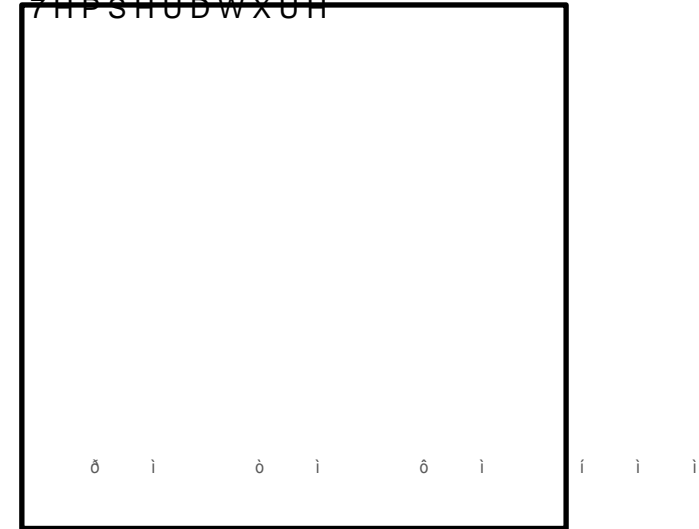

FIG.7: $V_{CE} \sim I_C$ & $V_{CE} \sim I_B$ CHARACTERISTICS & FIG.8: $V_{CE} \sim I_C$ & $V_{CE} \sim I_B$ CHARACTERISTICS

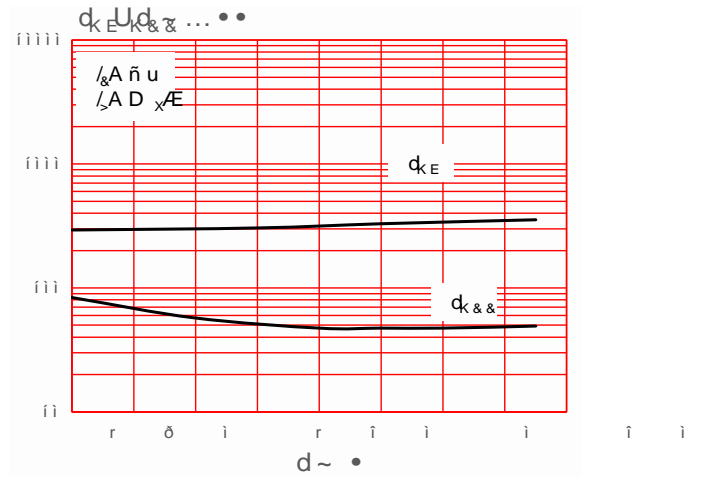
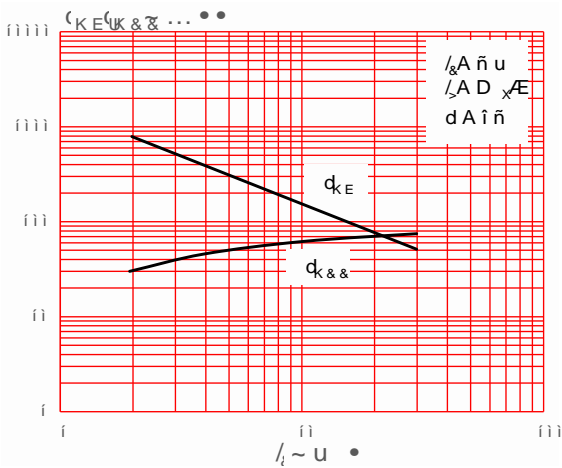

FIG.9: $V_{CE} \sim I_C$ & $V_{CE} \sim I_B$ CHARACTERISTICS & FIG.10: $V_{CE} \sim I_C$ & $V_{CE} \sim I_B$ CHARACTERISTICS

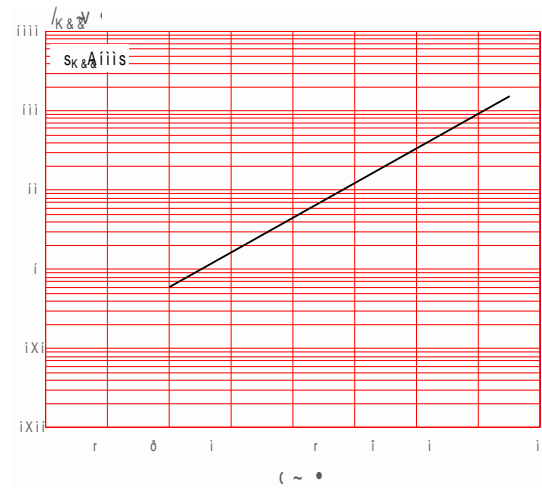
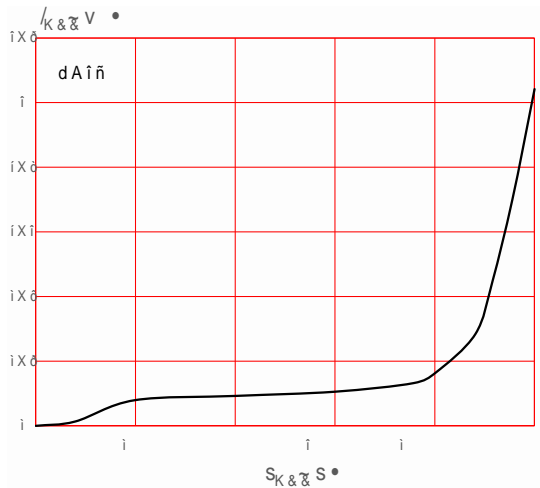
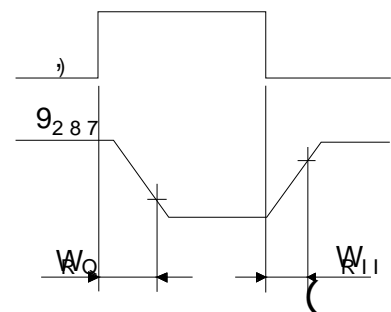
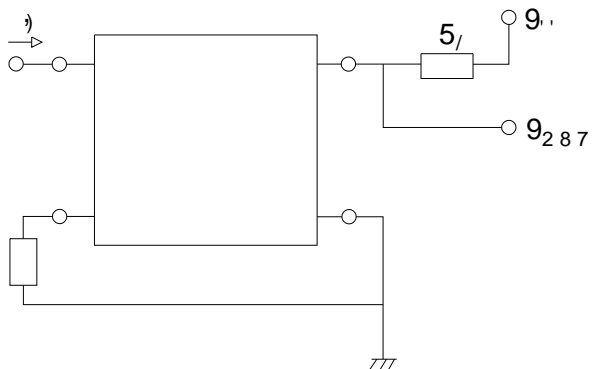
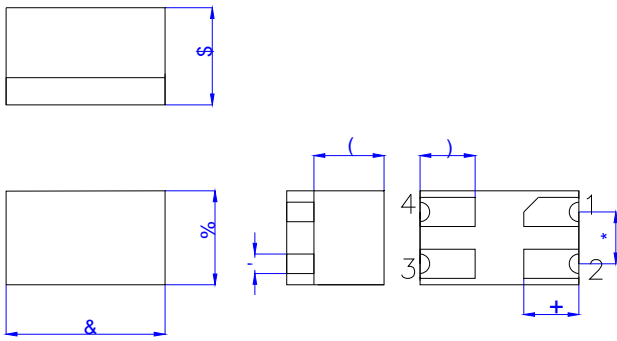

Fig.11: Switching Time Test Circuit and Waveform



Package Dimension (Unit: mm)



5 HI	'LPHQVLRQV					
	0 LOOLPHWHUV			, QFKHV		
	0 LQ	7 \ S	0 D [0 LQ	7 \ S	0 D [
\$						
%						
&						
'						
(
)						
*						
+						



CARRIER TAPE SPECIFICATIONS (Dimensions in mm unless otherwise stated)

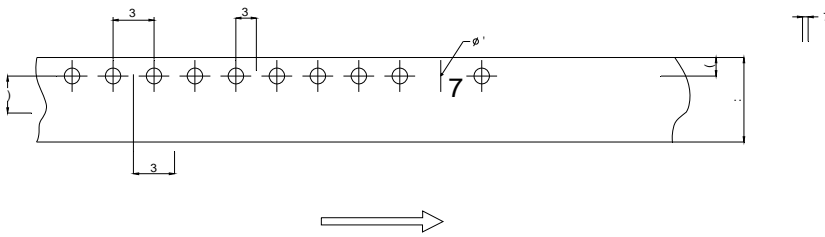

5HI	'LPHQVLRQV					
	0LOOLPHWHUV					
	0LQ	7\ S	0D[0LQ	7\ S	0D[
.						
3						
3						
(
)						
7						
:						

REFLOW INFORMATION

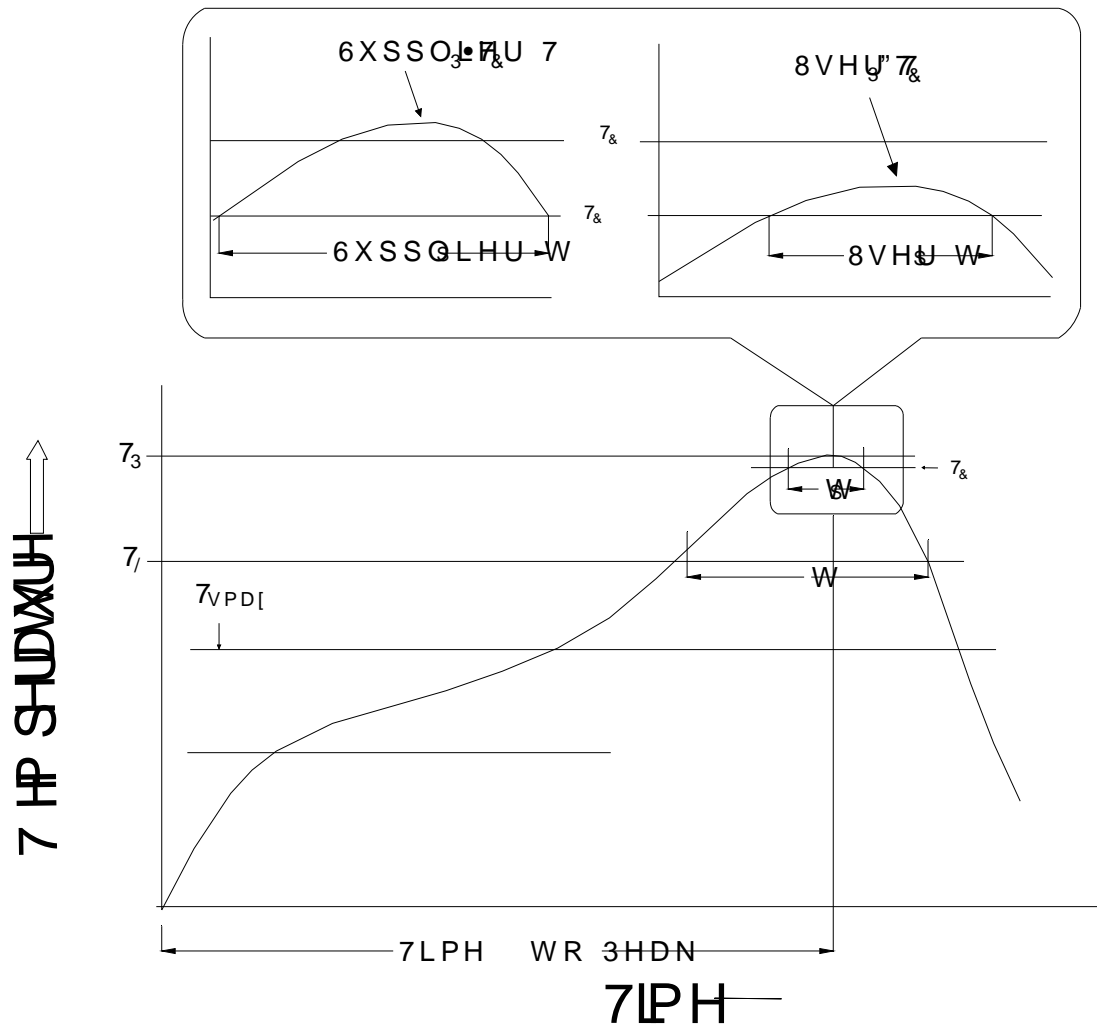

1RWH

5HIORZ VROGHULQJ LV UHFRPPHQGHG/ DWRZKH QHPSHWDWWDQW DQW D
\$YRLG GLUHFV FRQVHDVSRPHQZDQWXRUDFRU H[FHHGLQJ LWV PD
VWRUDJH WHPSHUDWXUH

\$SSOLFDWLRQ RKHUSRYXENRQLWLSOHGDDWHG WHPSHUDWXUHV ,QV
VFHQDULRV DQHPSVOLGRWRHFFHHG 1

(QVXUH WKH FRPSRQHQW KDV FRROHG SURPHQWQZLXPSWHDXHCL
PDQXIDFWXULQJ VWHSV

7KH FRPSRQHQW KDV BQKHODUZKHQVWDQGHGKFRGLWLRQV

5HFRPPHQG VWRUDJH 7HPS a f&

5HFRPPHQG VWRUDJH KXPLGLW\

06/ OHYHO 06/

,QIRUPDWLRQ IXUQXFKHQ/ LQ WKOLHGRHG WR EH DFFXUDWH D
-LDQJVVX -LH-LH 0LRRHOWHGDVROXLFHVQLRVUHRUSRQHLERQVHT
RI XVH ZLWKRXW FRQVLGHUDWLRQ IRG MWFKQIQURPDVWLRQ
LQ WKLV GRFXPHQVLDQJYXZLWHFRXWRQRWLFH DSDUW IURP V
VLJQHGH -LDQJVVXOLHVLZLFRKPKH DJUHHPHQW

3URGXFWV DQG LQIRUPDWLRQ SURYLGHG LQHWKWRGSDXPH
-LDQJVVX -LH-LH DVVXIPHLOQR\URVSRQVLQIULQJHPPHQW RI RW
ZKLFK PD\ UHVXOW IURP WKH XVH RI VFKLW SURFXPHQW DQGS HL
DQG UHSODFHV DOO LQIRUPDWLRQ SUHYLRXVO\ VXSSOLHG

 LV D UHJLVWHUHGDQJJDGHLPHUNRUFURHOWHFWURQLFV & R
&RS\ULJKW -LDQJVVX -LH-LH CLVRRHOWHFGVSRQHLGLJKWV UHVH