

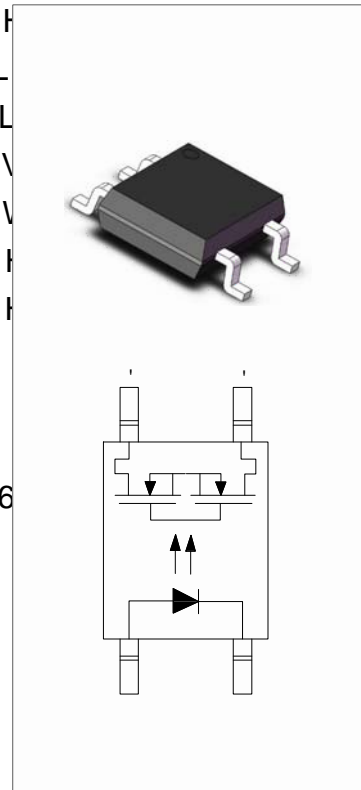

DESCRIPTION:

7KH SURGXFWV DUH SLQ RSWLFDQ QH
 \$O*D\$V LQIUUDHG HQ\$XWV LQVUDGHRGSHWL
 KLJK YROWDJH RXWVSLXWV LQHDV B D V R W LFL
 7KH GHWHFWRU FRQVWLWV RI D KLJK \
 DQG GULYHU FLUFXLWUH ZLGH SURGXG
 DQG WHVWLQJ HTXLSLQVWHBXSULHW
 LQG XVWULDQ PDFKLQHU\ DQG HTXLSPH



YLFH F
 G WR D
 ROWDL
 W
 LQJOH

MAIN FEATURES

- +LJK LVRODWLURQV
- 6LQJOH &KDQQHO 1RUPDOO\ &ORVHG 6
- 2SHUDWLQJ WHPSHUDWXUH WR f &
- 5(\$&+ 5R+6 FRPSOLDQFH
- +%0 + \$ 00 0 &'0 &
- &4& DSSURYHG
- 9'(DSSURYHG
- 8/ DSSURYHG

ABSOLUTE MAXIMUM RATINGS 7HP SHUDWXUH f &

)RUZDUG &XUUHQW ,)		
,QSW	3HDN)RUZDUG &XUUHQW	7	\$
	5HYUVH 9ROWDJH 95		
	,QSW 3RZHU 'LVVLSDWLRQ	3	
2XWSXW	/RDG 9ROWDJH	2	9
	&RQLQRXV ORDG FXUUHQW		,
	2XWSXW 3RZHU 'LVVLSDWLRQ	3	P:
7RWDO 3RZHU 'LVVLSDWLRQ	3WRW		P:
,VRODWLRQ 9ROWDJH	9LVR	8	9UPV
2SHUDWLQJ 7HP SHUDWXUH	7RSU	a	
-XQFWLRQ 7HP SHUDWXUH	7M		
6WRUDJH 7HP SHUDWXUH	7VWJ	a	
6ROGHULQJ 7HP SHUDWXUH	7VRO		



NOTE1 ίίί... • %οίμὸ,ί ὀϞϞ ρ μ ν Ϟ`

v

A



ORDERING INFORMATION

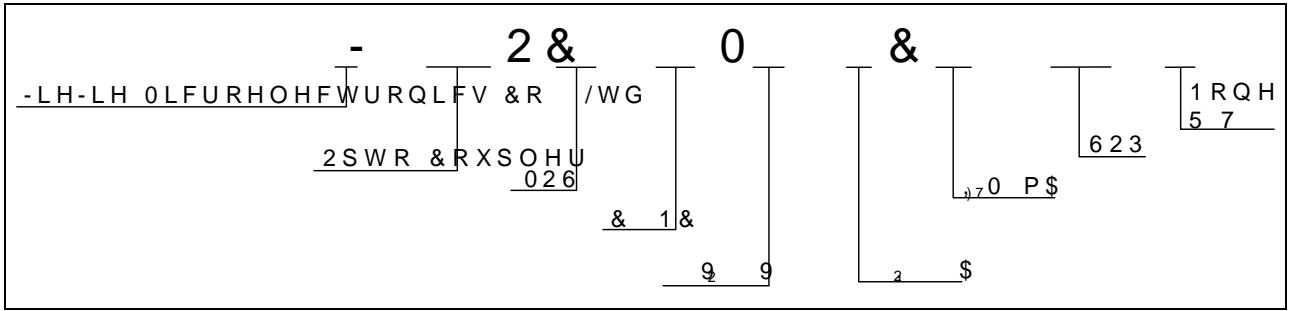

&

Packing Quantity	
Option	Quantity
E } v IZ	ïïïï hv]š•IZ o

MARKING

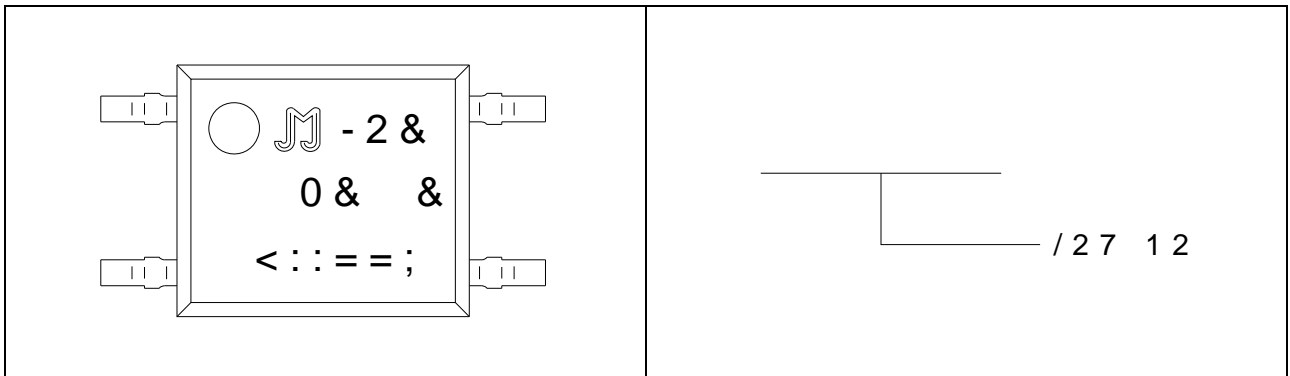



Characteristics Curves

/('URSRXW 9ROWDJH YV \$PELHQW XWSXW &XUUHQW YV 2XWSXW
7HPSHUDWXUH

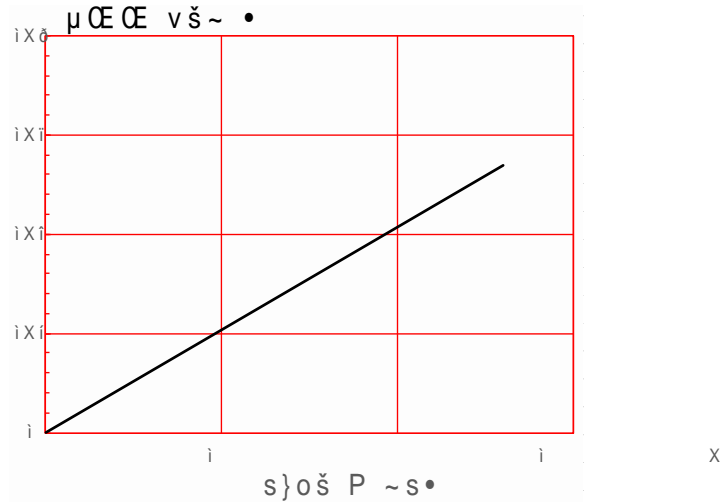
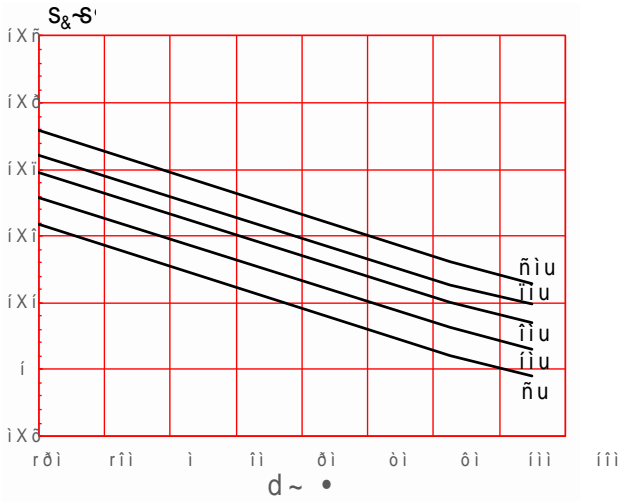

2Q 5HVLVW 5PELHQW 7HPSHUDWXUHRDG &XUUHQW YV \$PELHQW
7HPSHUDWXUH

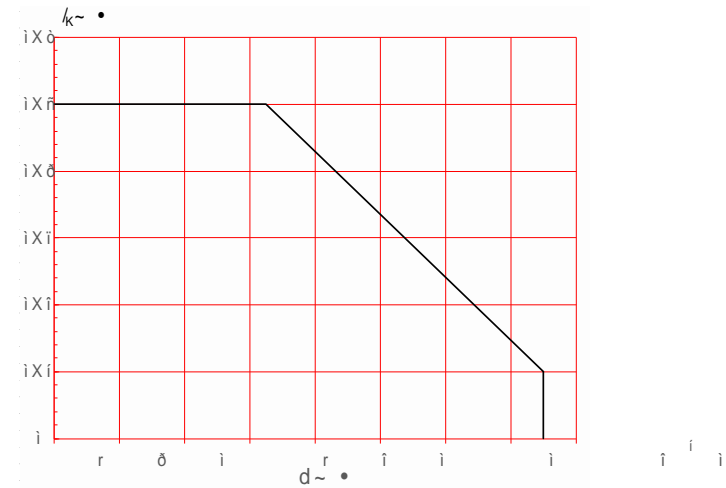
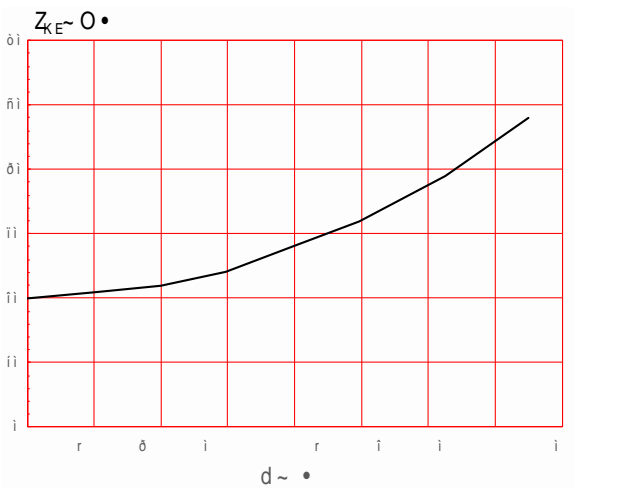

/(' 2SHUDWH &XUUHQW YV \$PELHQW 7XUQ 2II &XUUHQW YV \$PELHQW
7HPSHUDWXUH

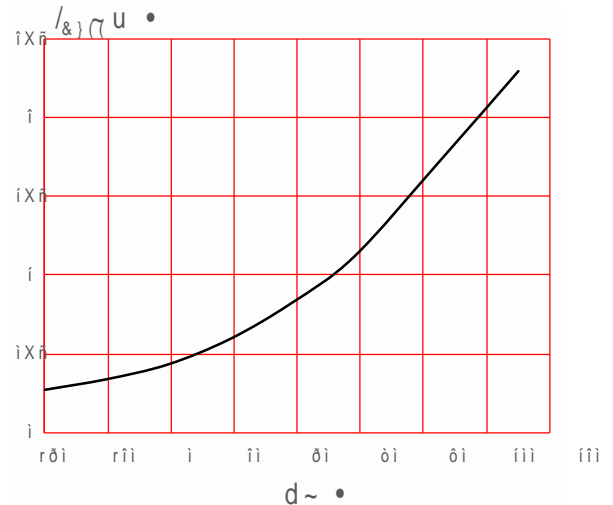
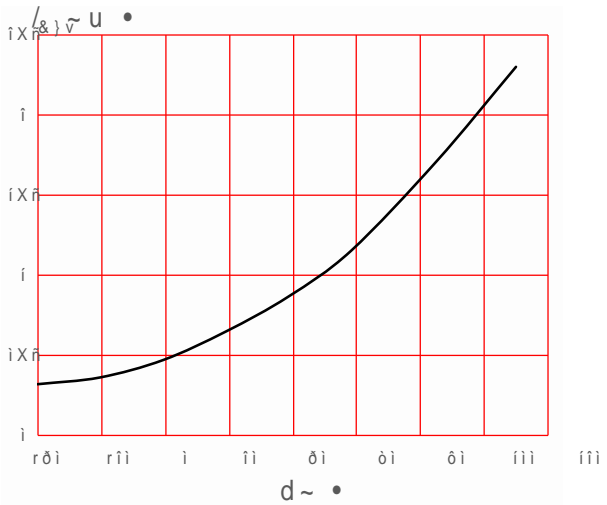



7XUQ 2Q 7LPH YV \$PELHQW 7HPSHUDWXUH 7HPSHUDWXUH 7LPH YV \$PELHQW 7HPSHUDWXUH

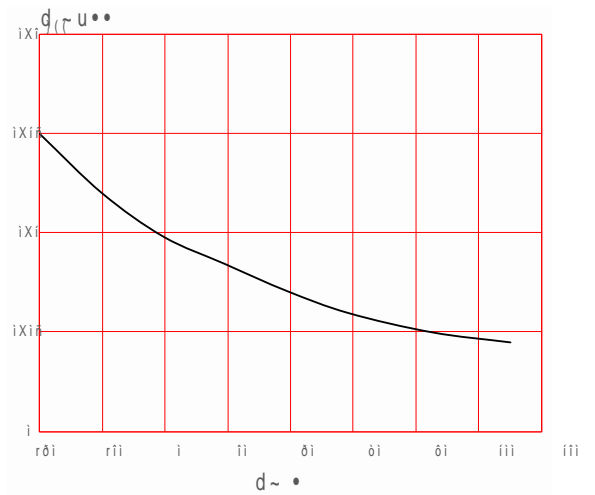
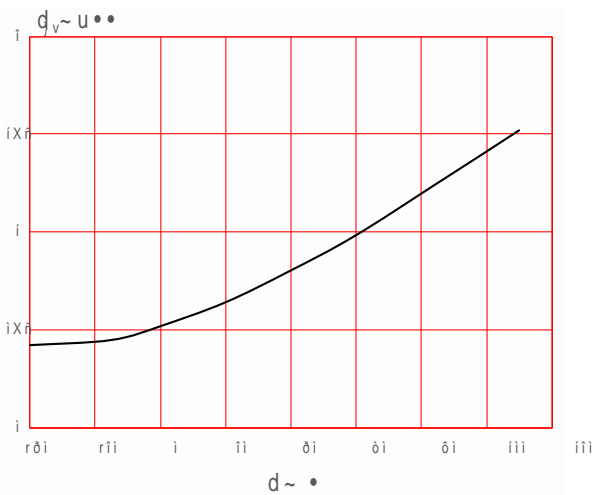

7XUQ 2Q 7LPH YV /(')RUZDUG &XUHHQW 2II 7LPH YV /(')RUZDUG &XUHHQW

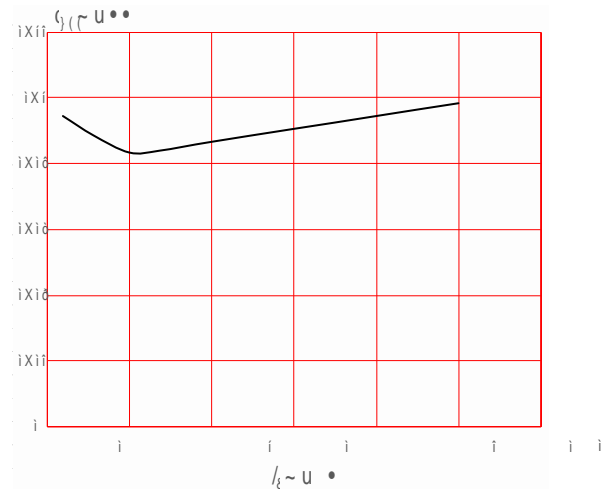
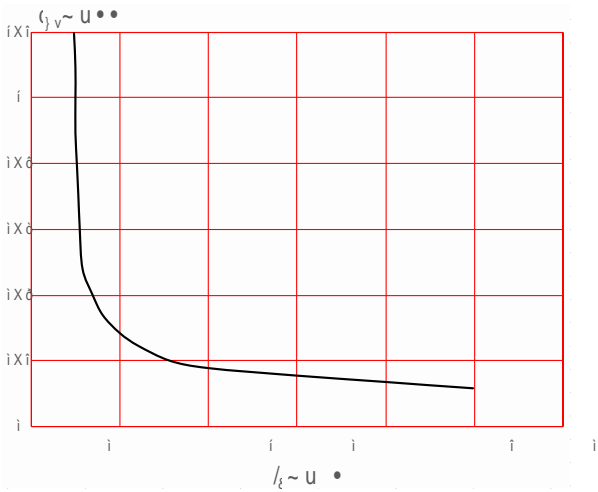

2II 6WDWH /HNDWHY &XURDG 9ROWDJH

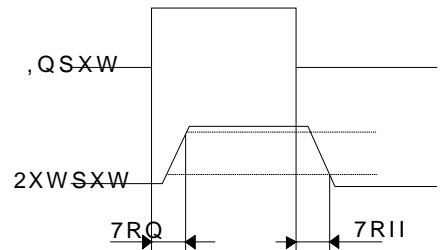
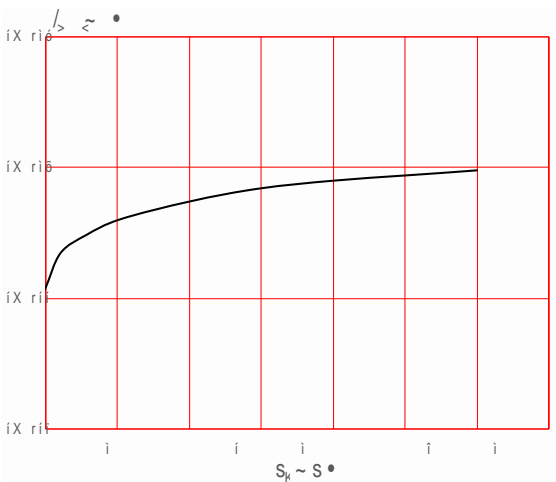



Package Dimension (Unit: mm)

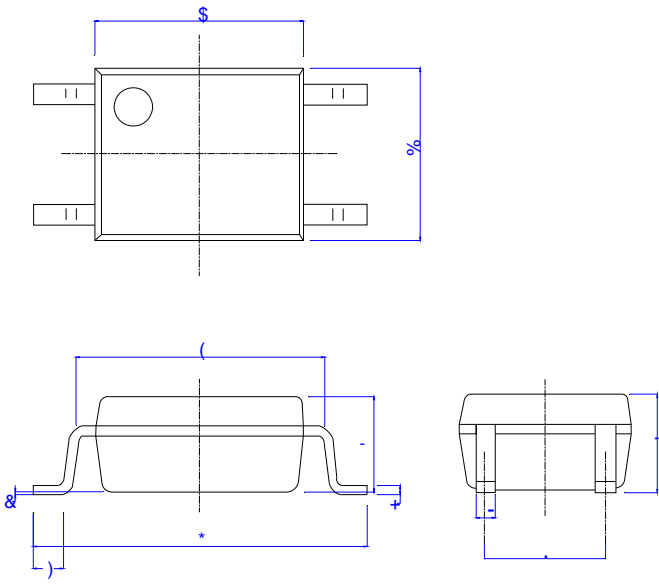

5HI	'LPHQVLRQV				
	0LOOLPHWHUV			,QFKHV	
	0LQ	7\S	0D[0LQ 7\S	0D[
\$					
%					
&					
'					
(
)					
*					
+					
,					
-					
.					

RECOMMENDED SOLDER MASK (Dimensions in mm unless otherwise stated)

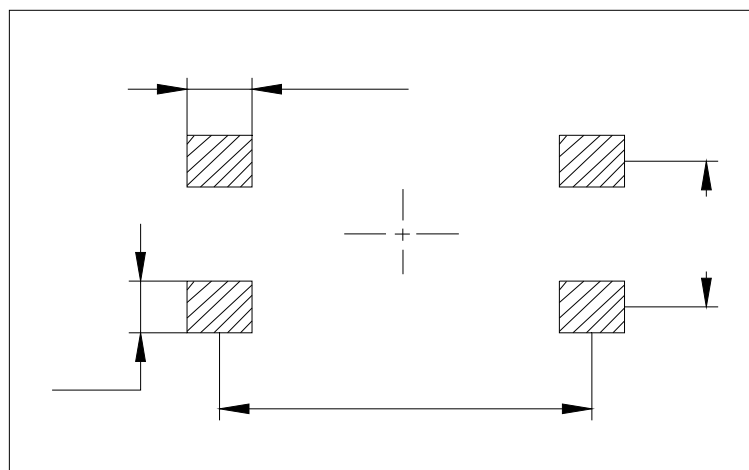



CARRIER TAPE SPECIFICATIONS (Dimensions in mm unless otherwise stated)

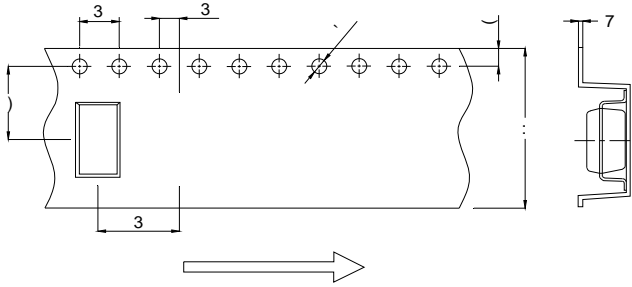

5 HI	'LPHQVLRQV					
	0LOOLPHWHUV			,QFKHV		
	0LQ	7\S	0D[0LQ	7\S	0D[
'						
3						
3						
3						
(
)						
7						
: bX, ` \$,: :						



REFLOW INFORMATION

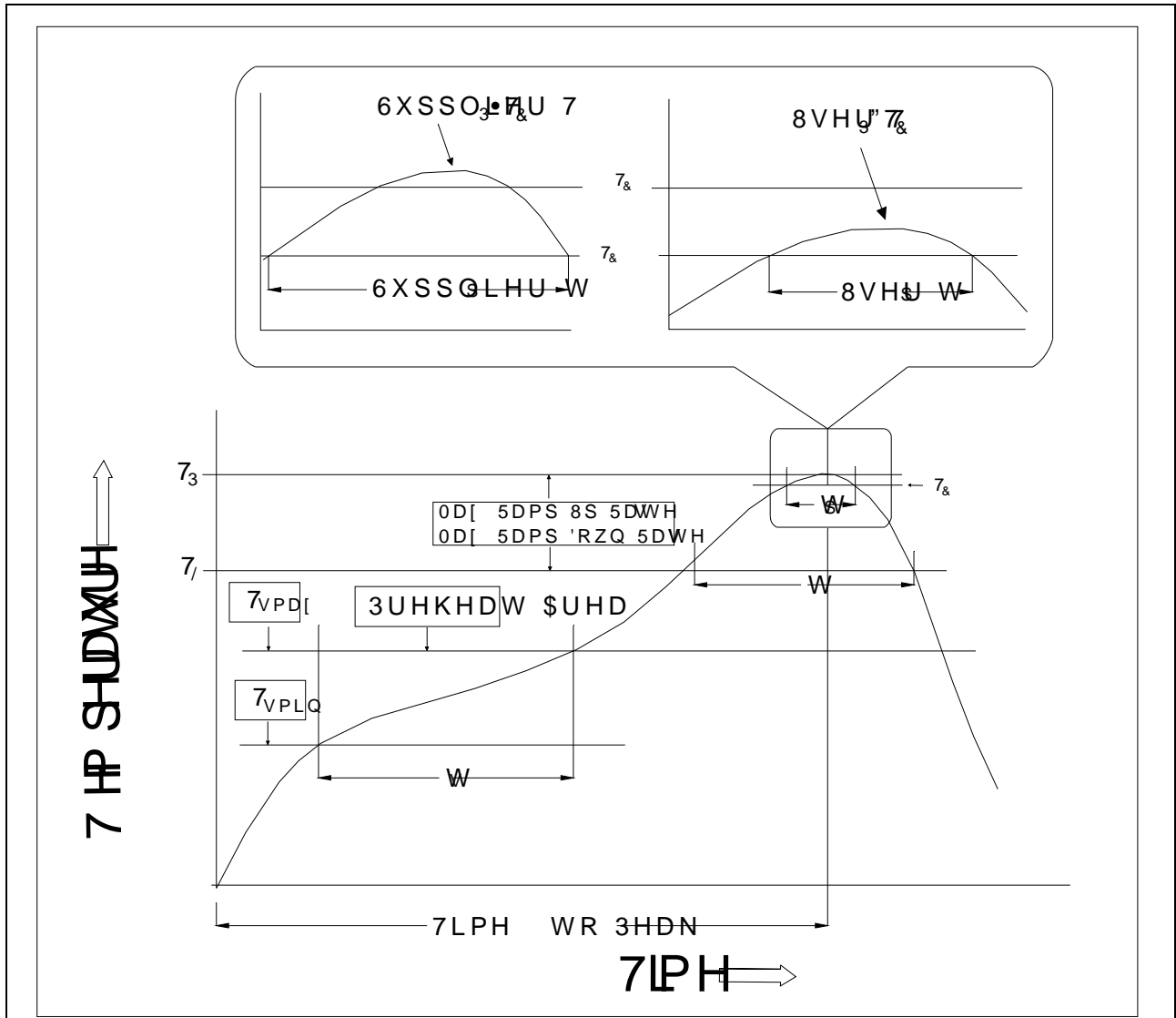

7HP SHUDWXUH		
7LPH		
7HP SHUDWXUH 0LQ	7VPLQ	
7HP SHUDWXUH 0D[7VPD[
7LPH WV IURP 7VPLQ WR 7VPD[VHFRQG V
5DPS XS 5DWH W/ WR W		VHFRQG PD[
/LTXLGXV 7HP SHUDWXUH 7/		
7LPH W/ 0DLQWDLQH \$ERYH 7/		VHFRQG V
3HDN %RG\ 3DFNDJH	7HP SHUDWXUH	
7LPH W3 ZLWKLQ		VHFRQG V
5DPS GRZQ 5DWH 73 WR		VHFRQG PD[
7LPH WR 3HDN	7HP SHUDWXUH	



1RWH

5HIORZ VROGHULQJ LV UHFRPPHQGHG/ DWRZKH QHPSHWDWWDQW DQW D
\$YRLG GLUHFV FRQVHDVSRPHQZDQWXRUDFRU H[FHHGLQJ LWV PD
VWRUDJH WHPSHUDWXUH

\$SSOLFDWLRQ RKHUSRYXENRQLWLSOHGDDWHG WHPSHUDWXUHV ,QV
VFHQDULRV DQHPSVOLGRWRHFFHHG 1

(QVXUH WKH FRPSRQHQW KDV FRROHG SURPHQVHQDQWLRSHWDXHQL
PDQXIDFWXULQJ VWHSV

7KH FRPSRQHQW KDV BQKHODUZKHQVWDQGHGKFRQGLWLRQV

5HFRPPHQG VWRUDJH 7HPS a f&

5HFRPPHQG VWRUDJH KXPLGLW\

06/ OHYHO 06/

,QIRUPDWLRQ IXUQXPHQW/ LQ WKOLHGRHG WR EH DFFXUDWH D
-LDQJVVX -LH-LH 0LRRHOWHG WDVROLFFVQLRVUHRUSRQHLERQVHT
RI XVH ZLWKRXW FRQVLGHUDWLRQ IRG MWFKQIRUPDWLRQ
LQ WKLV GRFXPHQW LQJYXZLWHFRXWRQRWLFH DSDUW IURP V
VLJQH G -LDQJVVXOLHVLZLFRKPKH DJUHHPHQW

3URGXFWV DQG LQIRUPDWLRQ SURYLGHG LQ HQWVVRG RSDXPH
-LDQJVVX -LH-LH DVVXPHLOQR\URVSRQVLQIULQJHPPHQW RI RW
ZKLFK PD\ UHVXOW IURP WKH XVH RI VXLW SURFXPHQW DQGS HL
DQG UHSODFHV DOO LQIRUPDWLRQ SUHYLRXVO\ VXSSOLHG



LV D UHJLVWHUHGDQWJDXGLHDUNRUFURHOWHFWURQLFV &R
&RS\ULJKW -LDQJVVX -LH-LH QLVRRHOWHFWURQLFV UHVH