



DESCRIPTION:

MAIN FEATURES

to 110

ABSOLUTE MAXIMUM RATINGS

				①			



		②	
			°C
			°C
			°C
			°C
°C			

NOTE1: 100 s pulse, 100Hz frequency

NOTE2: AC for 1minute, R.H.=40-60%

ELECTRICAL CHARACTERISTICS

						③	
					④		

NOTE3: Test voltage must be applied within dV/dt ratings.

NOTE4: Refer to Fig.14 & Fig.15



ORDERING INFORMATION

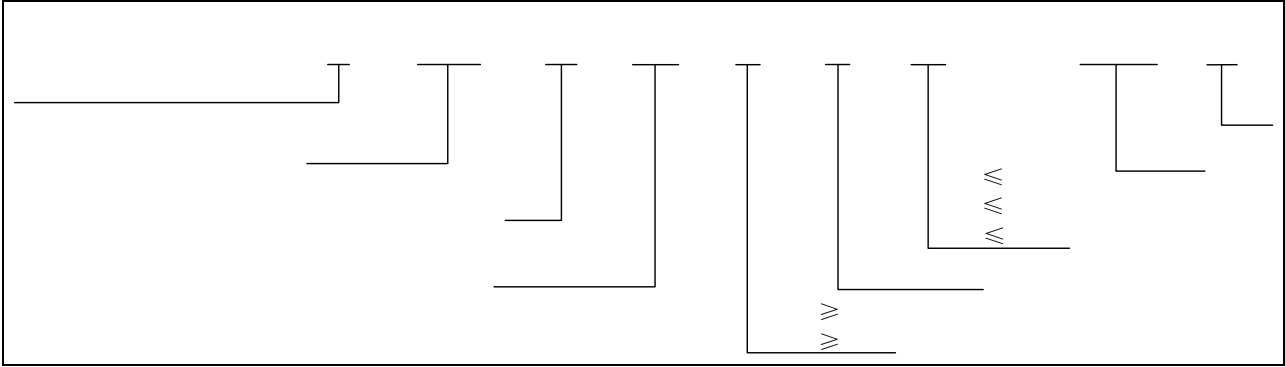

Packing Quantity

Option	Quantity
DIP	60Units/Tube
SMD	1200Units/Reel

MARKING

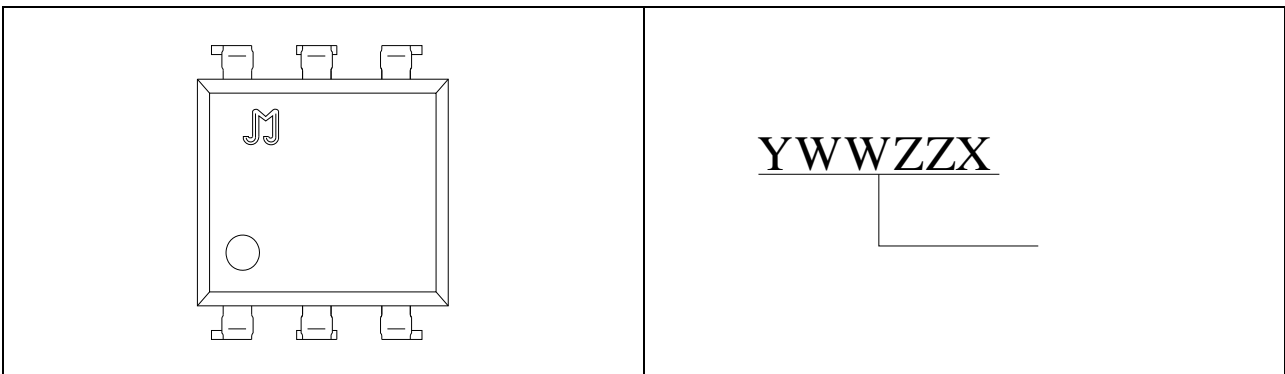



Characteristics Curves

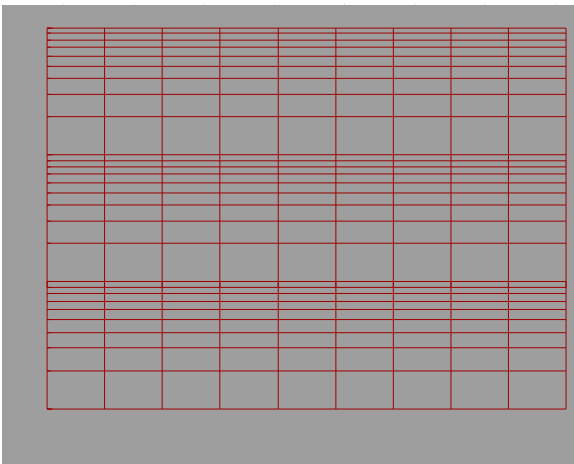
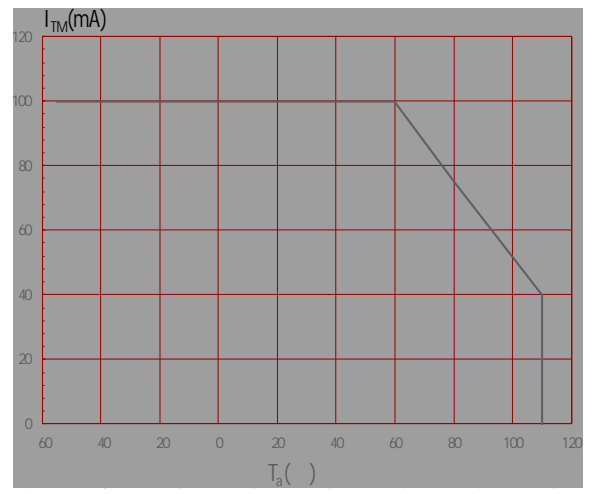
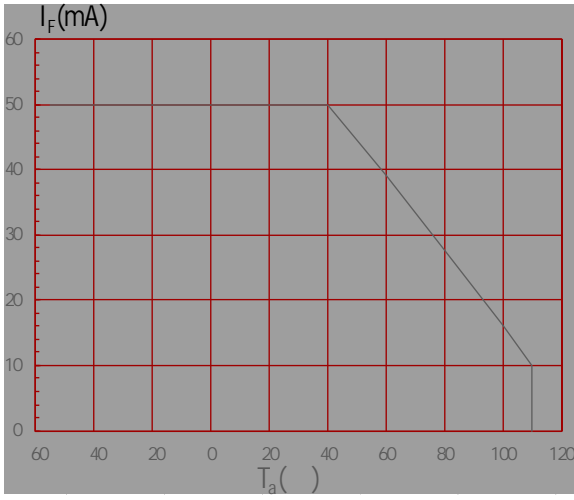

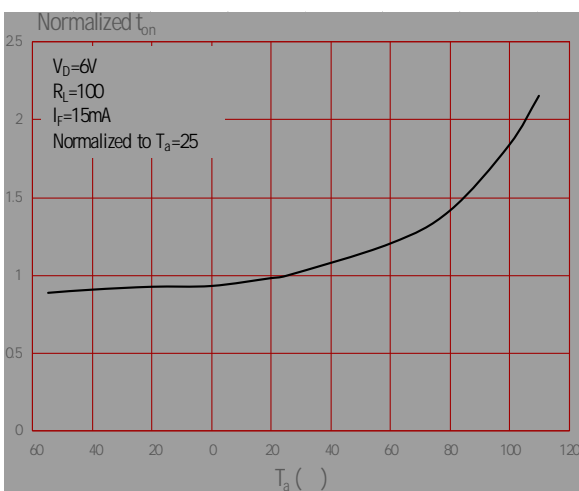
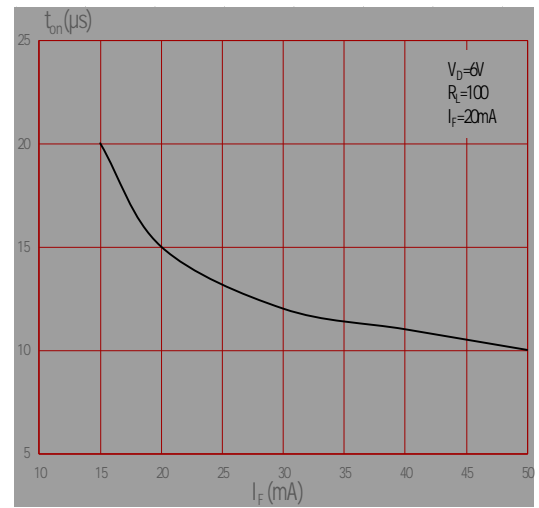
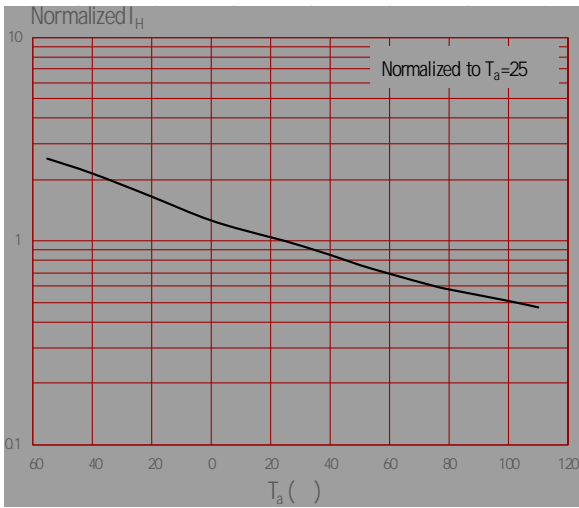
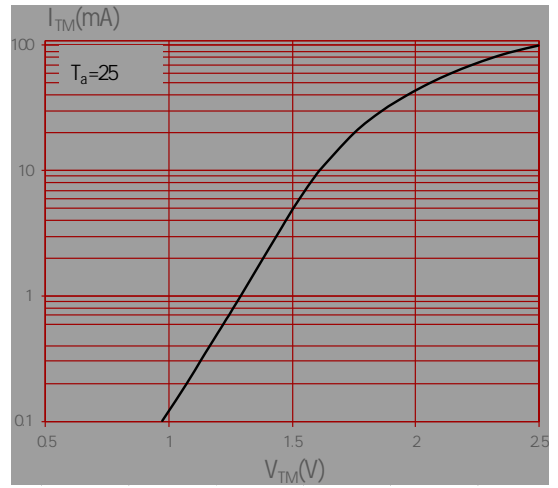
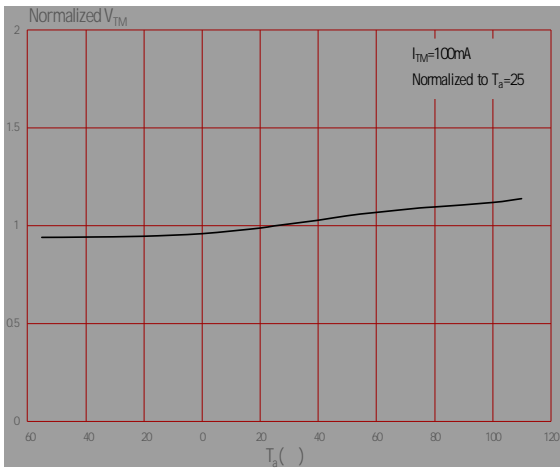



TEST CIRCUITS

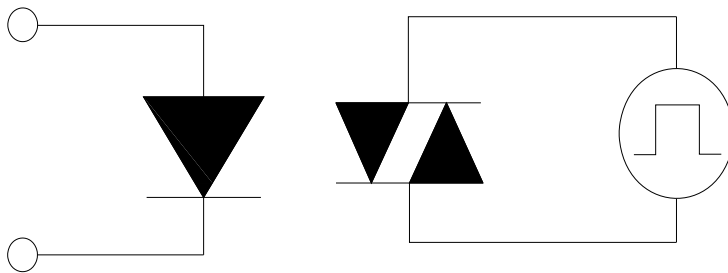

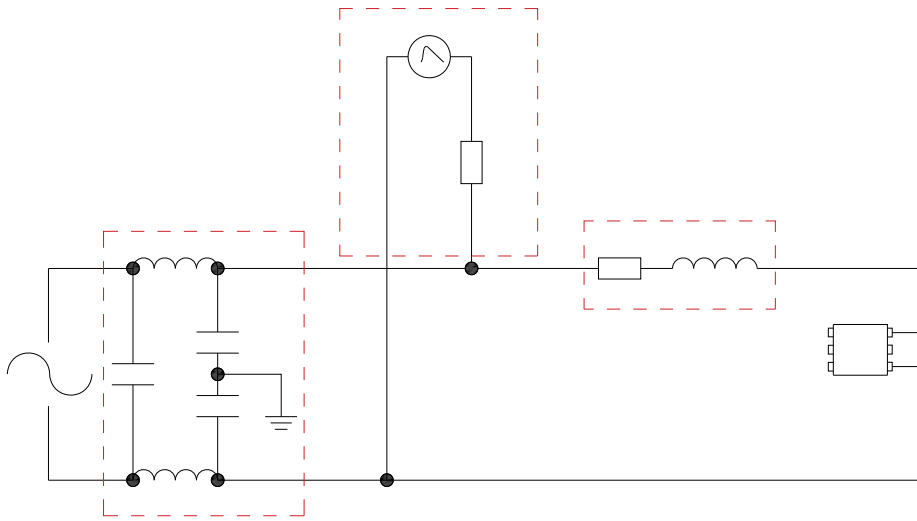

Package Dimension (Unit: mm)

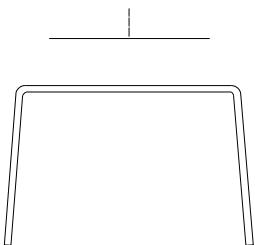





TUBE SPECIFICATIONS (Dimensions in mm unless otherwise stated)

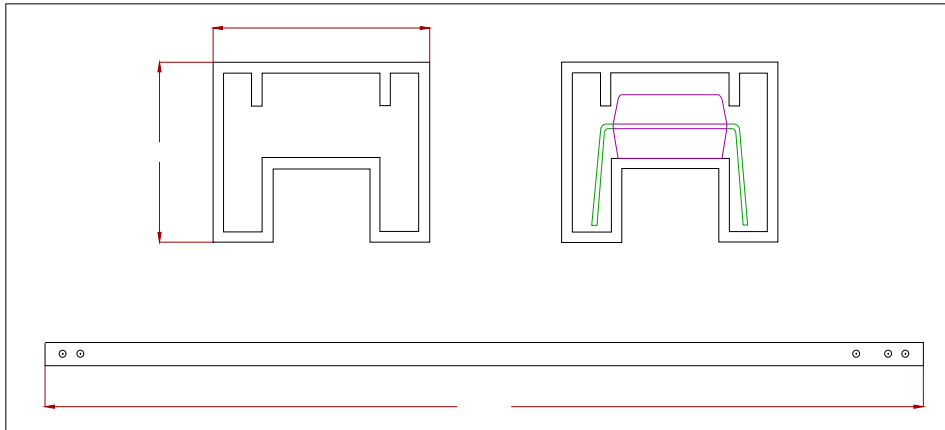

CARRIER TAPE SPECIFICATIONS (Dimensions in mm unless otherwise stated)

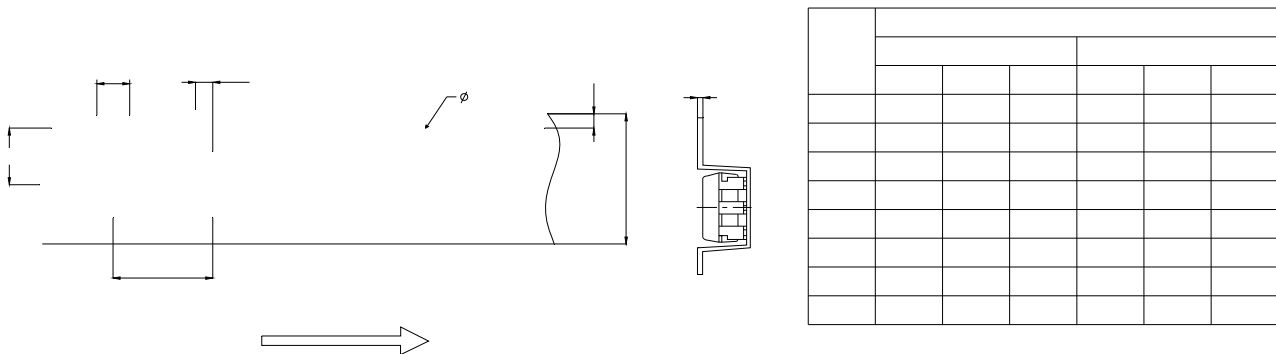



REFLOW INFORMATION

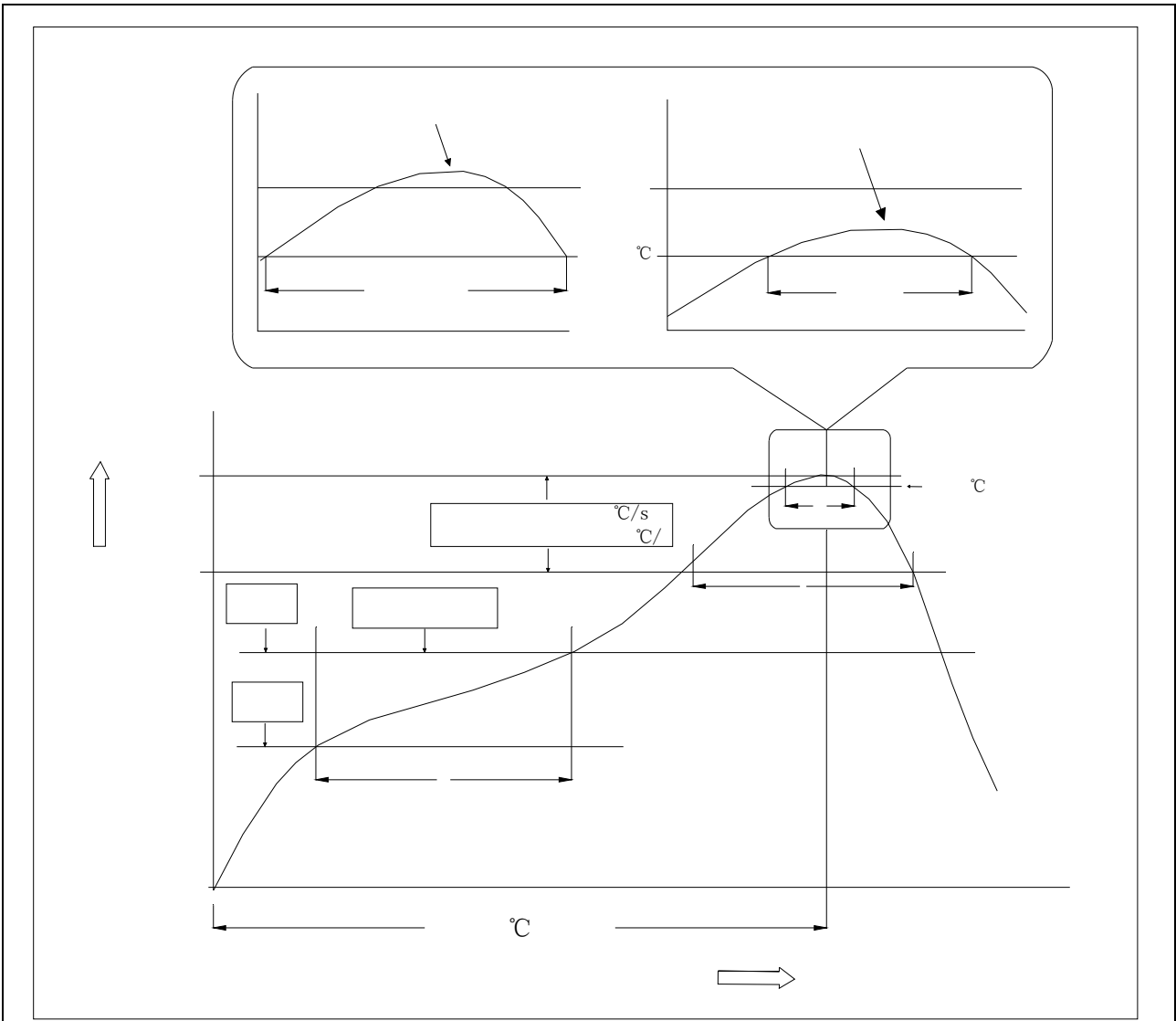

		°C
		°C
	°C	°C
	°C	°C
	°C °C °C	°C °C °C
°C °C		
	°C	°C
°C		



WAVE SOLDERING

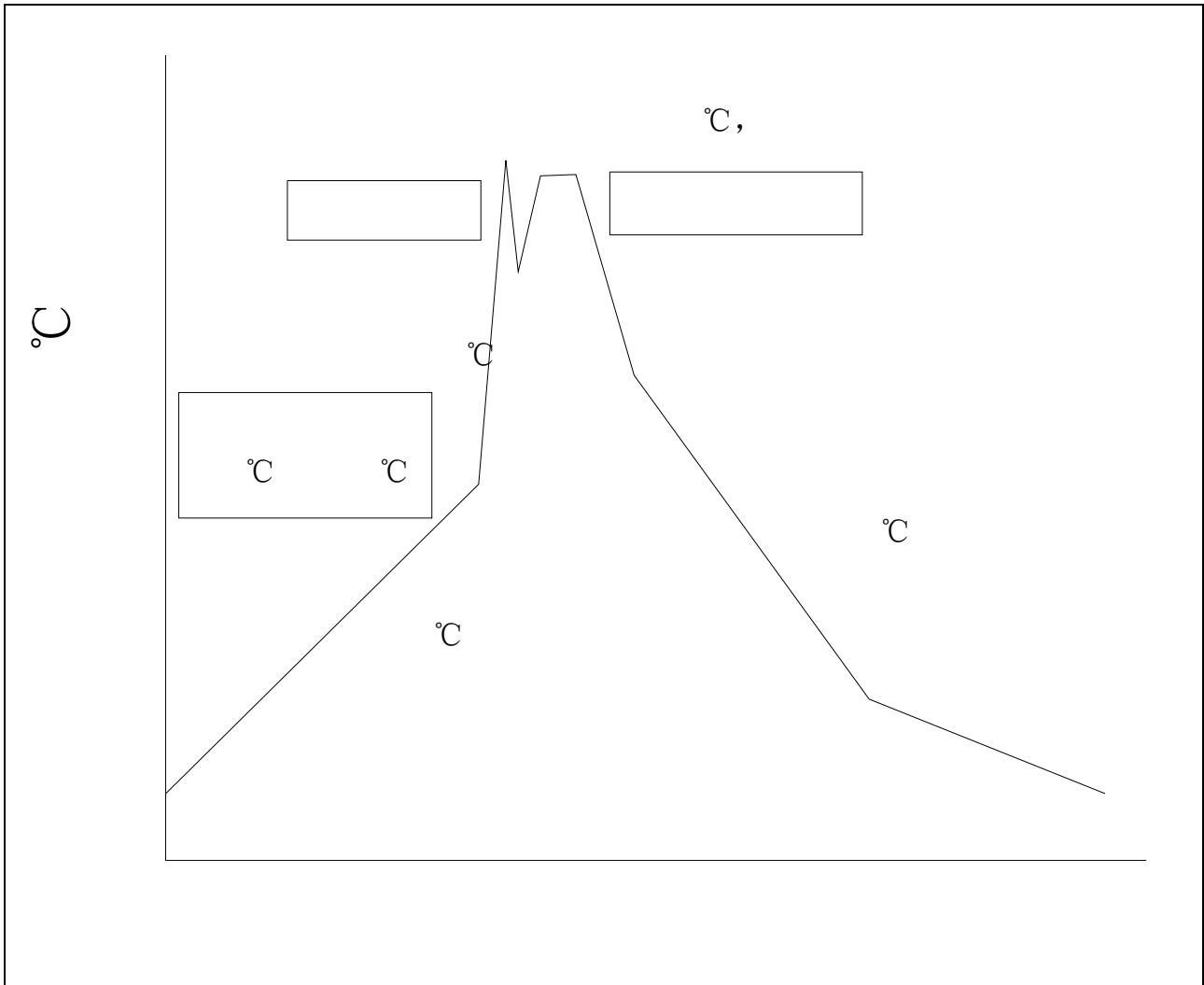

HAND SOLDERING BY SOLDERING IRON

± °C

