

Parameter		Symbol	Value	Unit

--	--	--	--

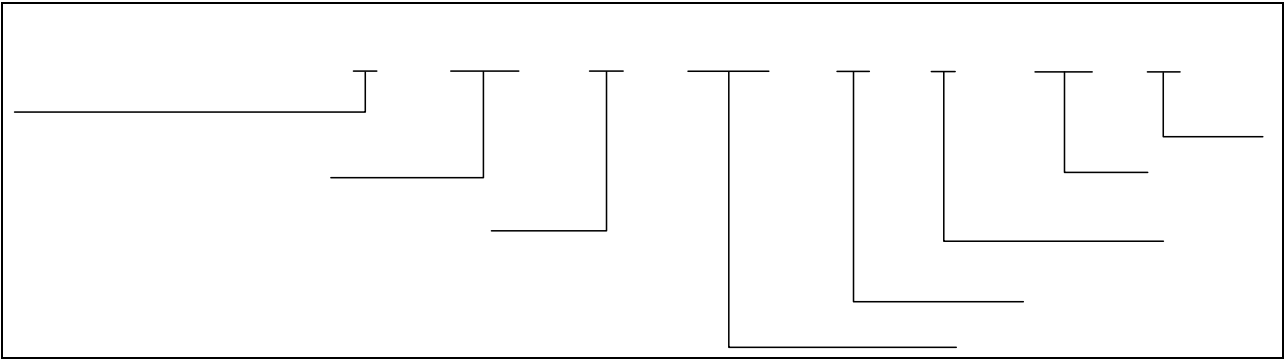

None/R	3000 Units/Reel

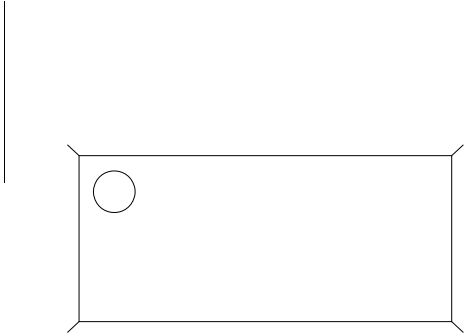

FIG.1:

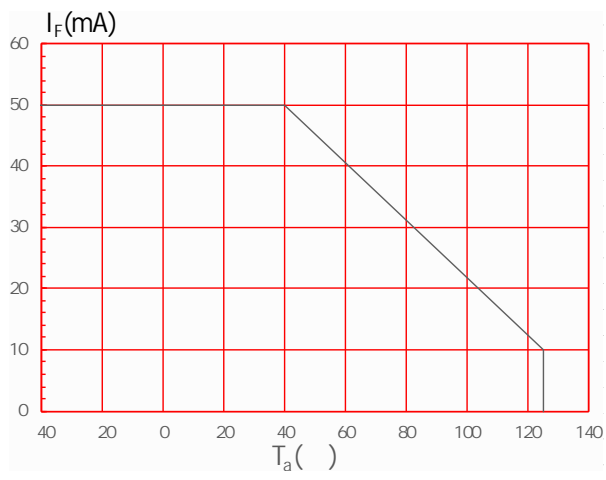

FIG.2:

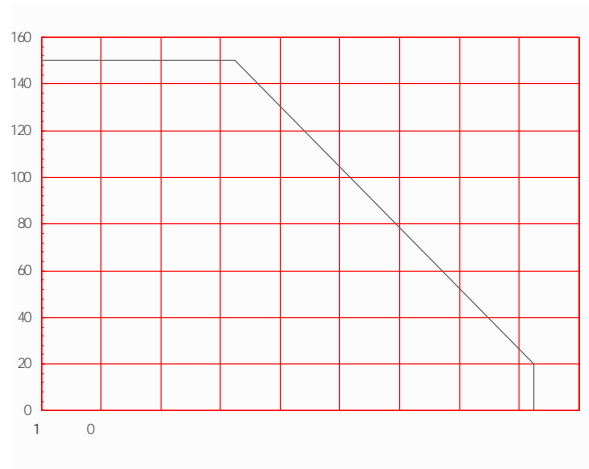

FIG.7:

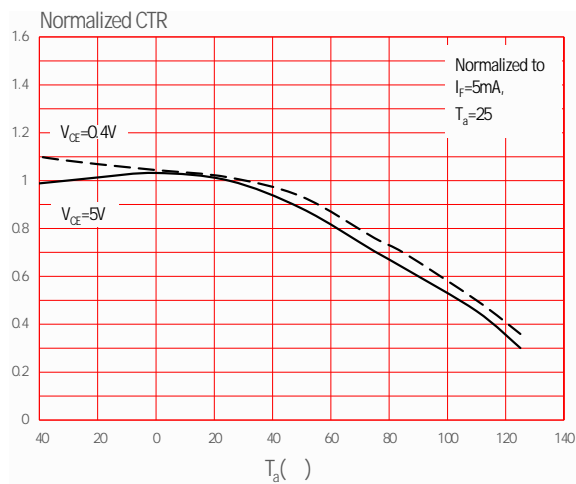

FIG.8:

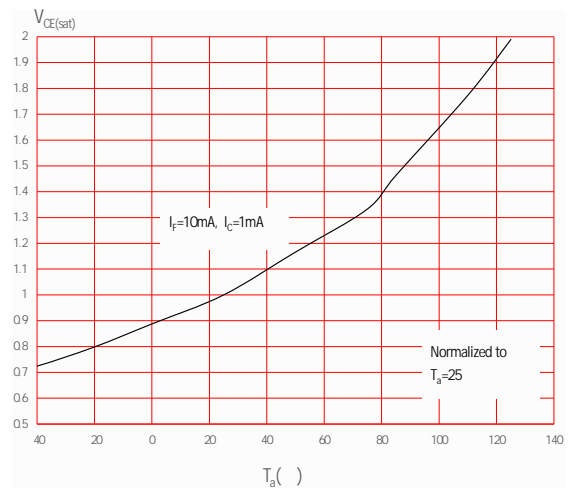

FIG.9:

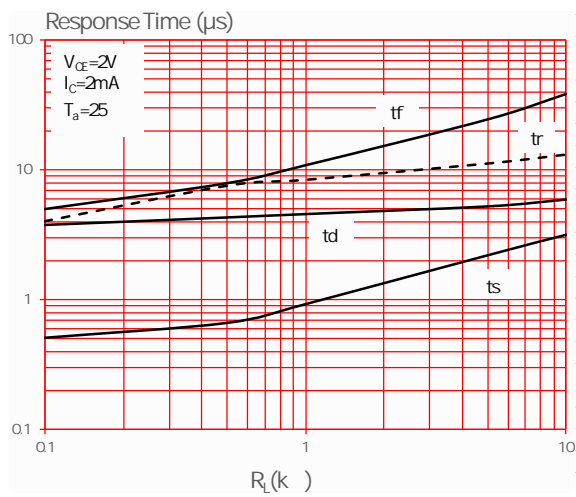

FIG.10:

FIG.11:

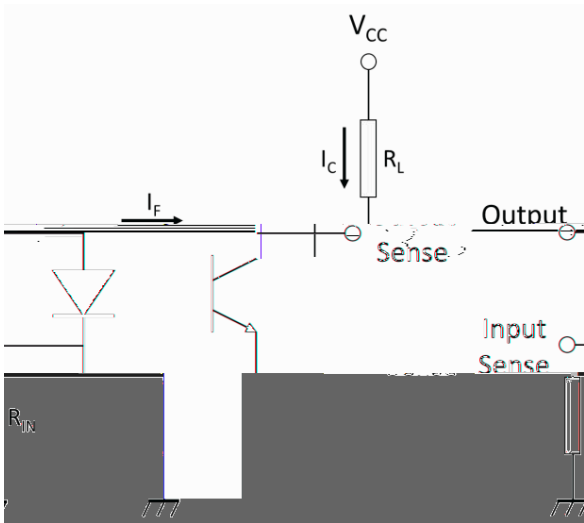

FIG.12:



FIG.13:

